



PTFM 6.1

Instruction Manual

Manual Rev 1.1



Note: This page has been left blank intentionally.

CONTENTS

CARRY CASE.....	4
INTERNAL BATTERY.....	5
CHARGER.....	5
TRANSDUCER CONNECTIONS.....	6
USB-C CONNECTIONS (CHARGER, MODULES)	6
TRANSDUCER CABLES.....	7
TRANSDUCERS.....	7
KEYPAD.....	8
MENU STRUCTURE	11
MESSAGES.....	13
STATUS.....	13
PASSWORD.....	14
MAIN MENU.....	15
UNITS/MODE	15
SETUP	17
CALIBRATION.....	21
DATA LOGGING.....	22
RETRIEVING LOG FILE.....	22
SPECIAL FUNCTIONS	23
CONFIGURATION.....	25
SENSOR MOUNTING	26
TYPICAL SE16A SENSOR INSTALLATION.....	27
TYPICAL SE16B SENSOR INSTALLATION	28
TYPICAL SE16C SENSOR INSTALLATION.....	29
TRANSDUCER INSTALLATION IN WET LOCATIONS	35
COMMON QUESTIONS AND ANSWERS	36
APPLICATIONS HOTLINE.....	38
PRODUCT RETURN PROCEDURE	38
APPENDIX A - CONVERSION TABLE.....	42
APPENDIX B - PIPE CHARTS.....	43
APPENDIX C – LIQUID SPEED OF SOUND DATA.....	47

IMPORTANT NOTE: *This instrument is manufactured and calibrated to meet product specifications. Please read this manual carefully before installation and operation. Any unauthorized repairs or modifications may result in a suspension of the warranty.*

If this product is not used as specified by the manufacturer, protection may be impaired.

CARRY CASE

The PTFM 6.1 is packaged in an orange IP67 carry case with protective molded foam. The foam is molded the same for all of the different ways the PTFM 6.1 can be equipped, but filled based on the original order. The drawing below shows how the various components included with the PTFM 6.1 are populated into the molds:

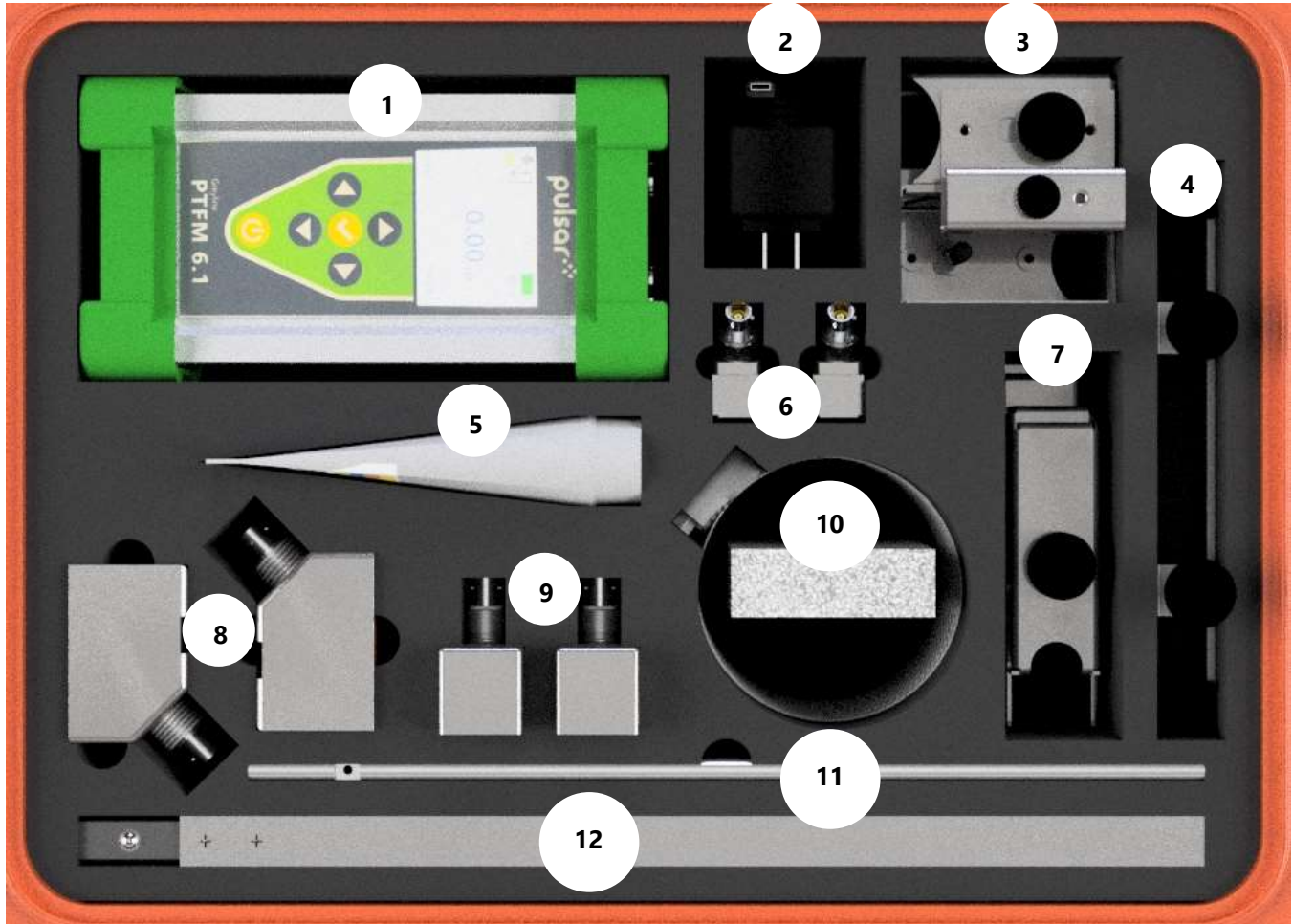

Legend

Position	Description	Position	Description
1	PTFM Electronics	7	SE16B Mounting Brackets
1 (Underneath)	Transducer cables, sanding block	8	SE16C Transducers
2	Wall Charger	9	SE16B Transducers
3	SE16C Transducer Mounting Brackets	10	Hose clamps, up to 3 pairs of different sizes, black marker, interchangeable plugs for charger
4	SE16A Transducer Mounting Rail	11	SE16B Alignment Rod
5	Coupling Compound, 3 oz Super Lube®	12	SE16C Alignment Bar with Built-In Ruler
6	SE16 Transducers		

INTERNAL BATTERY

WARNING: The PTFM 6.1 includes a lithium-ion battery. For your safety, operate only within the specifications put forth by Pulsar.

- A built-in rechargeable lithium-ion battery supplies power for approximately 15 hours of continuous operation when fully charged.
- When you first use the PTFM 6.1, the battery fuel gauge system needs a couple of charge and discharge cycles to full acclimate. The meter may reach 100% charge or 0% discharge faster than anticipated until the acclimation is complete.
- State of charge is shown when the meter is ON, or when the meter is in STANDBY mode only. The rate of charge is the highest only when ON or in STANDBY mode as well. Therefore, it is suggested that the meter is only charged while in one of these two modes.
- When the charge of the battery reaches 100%, the meter will reduce the charge current to avoid damaging or degrading the battery. In this state, there will be a very slow discharge. When the meter reaches 98% charge while in this state, the current will go back up to charging levels until a 100% charge is reached. This cycle will repeat until the charger is disconnected or the meter powered OFF.
- When the battery reaches 5%, a pop-up message will appear stating that the charge is low, and that the meter will automatically shut-down at 0%. To clear this message permanently, connect the charger. To temporarily clear the message, press any button on the meter.
- A full charge from empty requires approximately 3 hours of charging using the included 3 Amp (15 Watt) charger.

CHARGER

Included with the PTFM 6.1 package is a mains-powered USB-C, 5 Volt & 3 Amp (15 Watt) charger. The power outlet connection type can be changed via the included modular plates.

For best results, use the included charger. However, a third-party USB-C cable connected to a third-party charger or battery bank will suffice. Charge speed may be slower than the included charger if the output is not capable of delivering 2 Amps at 5 Volts (10 Watts).

TRANSDUCER CONNECTIONS

The transducer cables are connected via the IP67 sockets on the top of the PTFM 6.1.

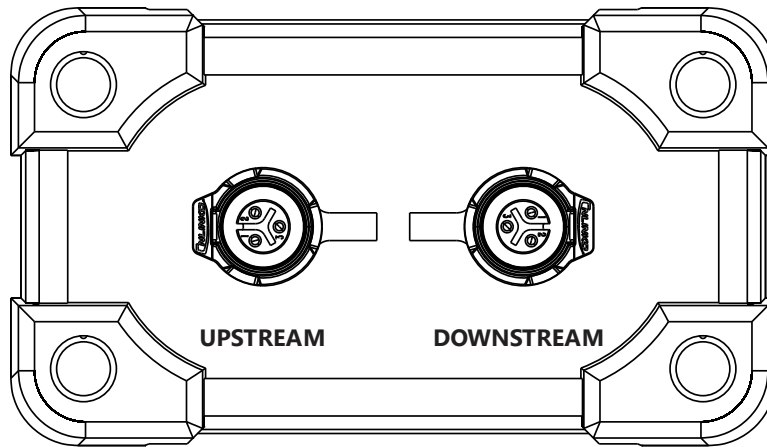

USB-C CONNECTIONS (CHARGER, MODULES)

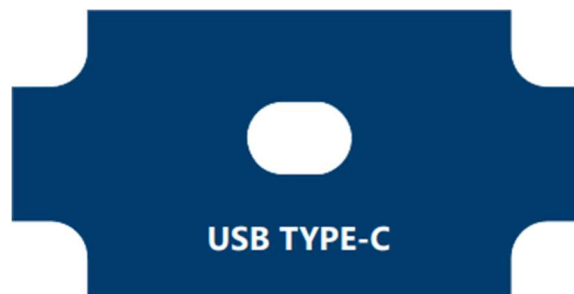

USB-C is a USB connector system with a rotationally symmetrical connector. Devices connected to USB-C may be hosts or peripherals. The PTFM 6.1 is able to make itself both, referred to as “Dual-Role-Data (DRD)” or “USB On-The-Go”.

When connected to a USB power delivery system, such as the included wall charger, a laptop port, an automobile port, or a portable USB power delivery device, the PTFM 6.1 becomes the peripheral and will charge.

When connected to a USB storage device, such as the included flash drive, the PTFM 6.1 becomes the host and will transfer data to the storage device.

The design of the PTFM 6.1 allows for future deployment of “modules” which will be able to plug in to the USB-C port on the PTFM, and expand its capability.

TRANSDUCER CABLES

Included with the PTFM 6.1 are a pair of 12-foot (3.4 m) triaxial cables, one end featuring a BNC plug, and the other a IP67 plug. The BNC plug will connect to any TTFM 6.1 or PTFM 6.1 transducer, the SE16A, SE16B, or SE16C. The IP67 plug will connect to the socket on the top of the PTFM 6.1.

The triaxial cables are marked on both ends as either “upstream” or “downstream”. The same markings are found on the label surrounding the sockets for the IP67 plugs. The purpose of these markings is to assist with connecting the meter to the transducers in the right orientation. As an example, in the picture below, when flow is from LEFT to RIGHT, the number **1** transducer is upstream, and number **2** is downstream. The reverse is true when flow is from RIGHT to LEFT.

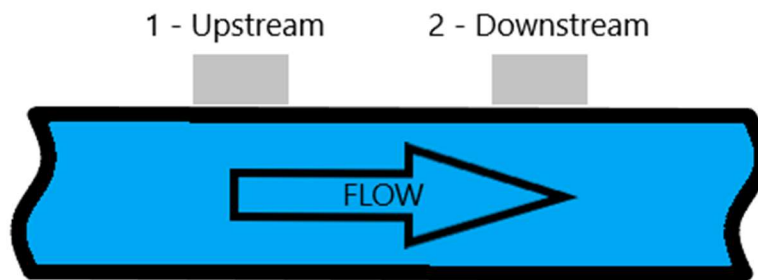

Example 2: Cross transducer orientation on horizontal pipe

IMPORTANT: The TTFM 1.0 and PTFM 1.0 transducers (SE16B only) utilized a coaxial BNC connector, not triaxial. Therefore, the PTFM 6.1 cannot be used with TTFM/PTFM 1.0 transducers, and vice-versa.

TRANSDUCERS

The PTFM 6.1 can be used with all three of the transducers available for Pulsar Measurement transit-time flow meters, the SE16A, SE16B, and SE16C. The PTFM 6.1 will be “wet” calibrated against a secondary standard for each transducer set ordered with the meter. When switching between transducer type in the PTFM 6.1 programming menu, the calibration data for each sensor will automatically change, so that the calibration certificate does not need to be referenced each time.

Each transducer type has a specific nominal pipe size range where they are ideal for use (recommended). Outside of this range, the transducer is likely to work but measurement integrity could be effected by the application not being as conducive as possible for transit-time measurement (suitable). See the chart below for the specific range.

TRANSDUCER NOMINAL PIPE SIZE RANGES

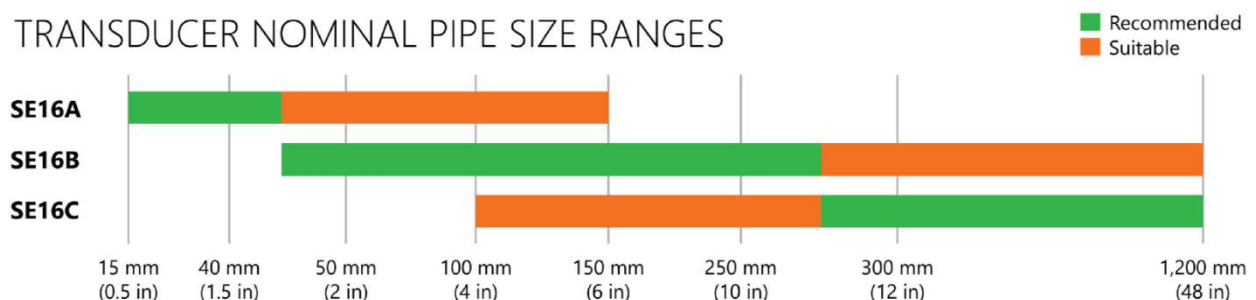

KEYPAD

Keypad layout and functionality is as shown and described below:

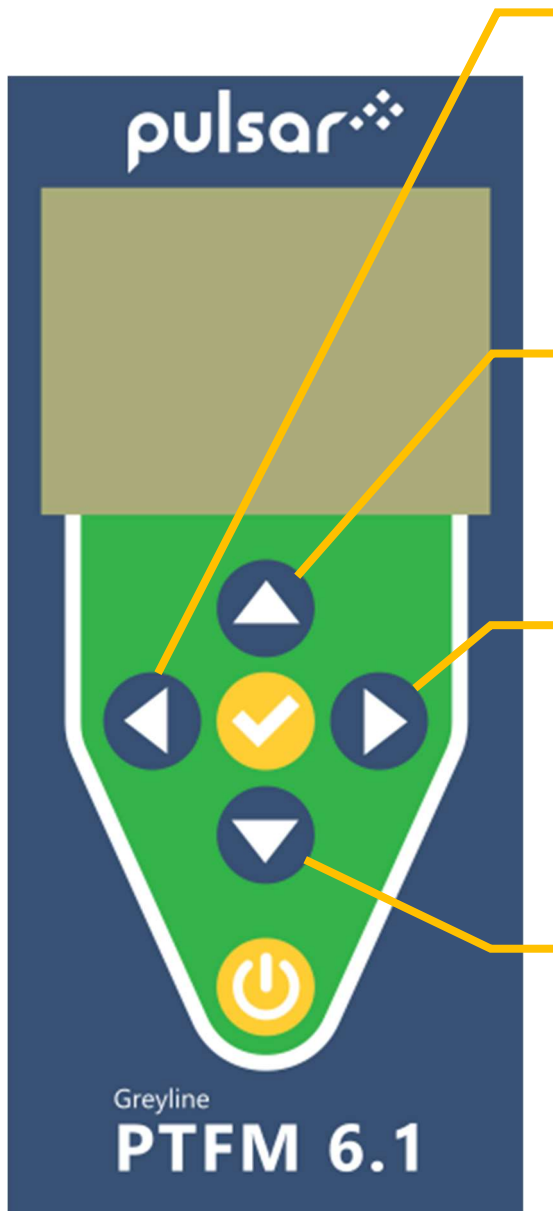

LEFT Arrow:

- From Main screen – Navigate to 24 Hr Log page
- In programming menus – navigate out of the Main Menu or sub-menu
- In pop-out menus – cancel the selection of a parameter. For numerical entries – moves the cursor left, unless on the left-most number, which will then cancel the numerical entry.

UP Arrow:

- From Main screen – Navigate to Messages page
- In programming menus – navigate up in the menus
- In pop-out menus – change the selection or numeric entry

RIGHT Arrow:

- From Main screen – Navigate to Main Menu programming page or Passcode entry
- In programming menus – navigate into the selected sub-menus, or bring up a pop-out menu for a parameter
- In pop-out menus – change the selected number in a numerical entry

DOWN Arrow:

- From Main screen – Navigate to Status page
- In programming menus – navigate down in the menus
- In pop-out menus – change the selection or numeric entry

KEYPAD (CONT.)

Keypad layout and functionality continues as shown and described below:

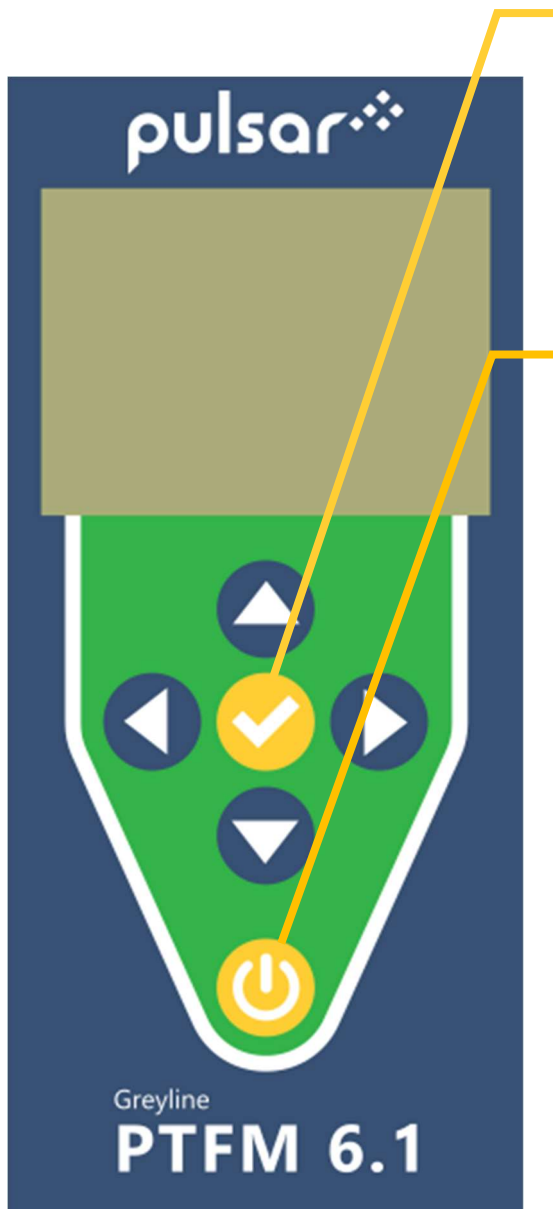
**CHECK Button:**

- From Main screen – not applicable
- In programming menus – will move the cursor back one level. Example: if in the Units/Mode sub menu, CHECK will move back to Main Menu.
- In pop-out menus – confirms the selection of a parameter or numerical entry.

POWER Button:

- From Main screen – Press & hold for one second for the Power Mode selection pop-out. Immediately release to enter STANDBY mode. Continue holding for POWER OFF.
- In programming menus – exits to Main screen
- In pop-out menus – exits to Main screen

POWER ON/OFF & CHARGING

Press and hold the POWER button for 3-5 seconds to turn the meter on or off. When powering on, the meter will display a boot-up screen with the Pulsar Measurement logo:

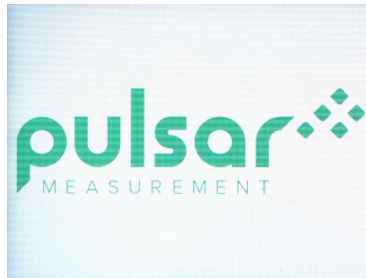

When powering off, the meter will display a pop-up message that continuing to hold the POWER button will completely shut off the meter, while releasing the POWER button will put the meter into stand-by mode:

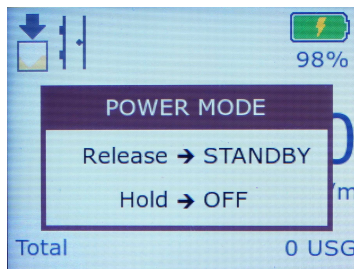

Stand-by mode is intended to be used to put the meter in a low-power state, while keeping the processor awake so that periodic data logs can be made by returning to normal-power, taking the measurement, then returning to low-power standby again. This "standby logging" functionality will form part of a later release, therefore it is not recommended that the meter is placed into standby mode since the battery will drain significantly faster than if completely off.

Charging should only be done while the meter is ON. This allows the regulation circuitry to charge at the optimum rate, ensuring a fast and efficient charge, and maximizing battery life. The meter will automatically slow the charging rate when maximum charge is approached. Once the battery charge drains slightly, to 97% with the charger still connected, the meter will automatically turn on the charger current again to return to 100%.

Third-party USB-C charging devices or battery banks are acceptable to use. Charge speed may be slower than the included charger if the output is not capable of delivering 2 Amps at 5 Volts (10 Watts).

MENU STRUCTURE

The structure of the menu pages on the PTFM 6.1 is as follows. Using the buttons as shown below will navigate between the different menus:



1 – Inserting a USB drive while on this page will download the 24 hr log data to the USB in .csv format

2 – Will not appear if the Set Password parameter in the Special Functions menu is set to 0000

MAIN DISPLAY

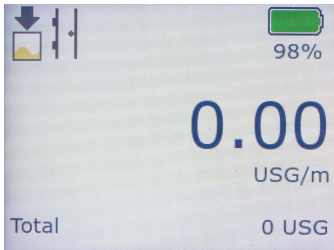









The main display's top row shows icons for the status of the data logger, signal path and quality, charging status, battery fuel gauge percentage, and data logging download status when a USB-C drive is inserted while on this page.

In the middle row of the main display you will see the current numeric value of either the flow rate or velocity, and the associated units of measurement as selected in the Units/Mode menu.

The bottom row shows the total volume accumulated over time, with associated units of measurement as selected in the Units/Mode menu.

ICONS:

-  Data Logger LOGGING
-  Data Logger STOPPED
-  Sensor Good & Signal Strength > 0%
Sensors will be on same side of pipe in 2 or 4 cross (shown), and signal path animation matches 2 or 4 cross as well
Sensors will be across the pipe in 1 cross
-  Sensor Good & Signal Strength = 0%
-  Sensor Open (flashing "X") & Sensor Short (static "X")
Message next to icon will also specify sensor status
-  Data Logger downloading (animation shows USB filling)
-  Data Logger download complete
-  Battery charging

MESSAGES

Messages	
Data Log	Logging
Log Used	0.00007%
Battery Level	98%
Charger	Off
Sensor	Good

Pressing the UP arrow button from the Main Display will take you to the Messages page. This page shows the status of the Data Log in plain text, percentage of the Log Used, the Battery Level fuel gauge in plain text, Charger status, and Sensor status in plain text. Press DOWN, CHECK, or POWER to return to the Main Display.

Data Log – Status can be Stopped (not logging) or Logging. Matches state of the icon on the Main Display.

Log Used – Percentage used of the internal storage for the data log. The PTFM 6.1 has storage for approximately 12.5 million logs, or almost 4 years at the fastest logging interval of 10 seconds/log.

Battery Level – Percentage remaining in the fuel gauge. Meter will automatically shut-down at 0% with no charger connected.

Charger – Shows either Charging or Off depending if charger is connected and charging (Charging) or meter is not charging with/without charger connected (Off). The meter can be not charging with charger connected when the battery reaches 100% with the charger connected.

Sensor – Shows Good, Low Signal, Short, or Open. Low Signal indicates that the sensor connection is good, but there is no signal (entrained air or solids in the line, or empty pipe). Sensor Short or Sensor Open indicates a short or open connection in the transducer cable(s) or transducer(s) themselves. Use a multimeter to check for shorts or opens in the cable(s) and transducer(s).

STATUS

Status	
Velocity	0.00 ft/s
Flow	0.00 USG/m
Min Flow	4.00 USG/m
Signal	100%
Exp. SOS	4901 ft/s
Meas. SOS	4867 ft/s

Pressing DOWN from the Main Display will take you to the Status page. This page shows the status of the measurement itself, Flow Velocity currently measured, Flow Rate currently measured, Min Flow (read-only) as set in the Calibration menu, Signal strength, Exp. SOS (Expected fluid Speed Of Sound), and Meas. SOS (Measured fluid Speed Of Sound). Press UP, CHECK, or POWER to return to the Main Display.

Velocity – Shows the measured velocity in either ft/s or m/s, as set in the Units/Mode menu.

Flow – Shows the measured flow rate in units set in the Units/Mode menu.

Min Flow – Shows the minimum flow rate as set in the Calibration menu. Any flow rate below the Min Flow results in the flow rate displaying as 0.0

Signal – Shows the magnitude of signal being received by the ultrasonic sensors. 100% is the ideal signal strength. Signal strengths less than 100% could indicate poor pipe conditions (corrosion), highly aerated water, or programmed setup parameters which don't closely match field conditions. Consideration should be made to use 1-cross installation method in such cases, if not already using it.

STATUS (CONT.)

Status	
Velocity	0.00 ft/s
Flow	0.00 USG/m
Min Flow	4.00 USG/m
Signal	100%
Exp. SOS	4901 ft/s
Meas. SOS	4867 ft/s

Exp. SOS - Displays the expected fluid speed of sound measurement, in units that match the Velocity. The expected speed of sound is based on the pipe, fluid, and temperature selection in the Setup menu.

Meas. SOS - Displays the measured fluid speed of sound, in units that match Exp. SOS. The meter calculates this value based on the time it takes for the signal to arrive from one transducer to another. Large differences between expected and measured speed of sound (> 10%) typically indicate an error in the setup of the instrument. Verify the following are correct in the Setup menu and with the physical installation of the transducers:

- Pipe Material
- Pipe Outer Diameter (OD)
- Pipe Wall Thickness
- Liner Type
- Liner Thickness
- Fluid Type
- Fluid Temperature
- Crossings
- Separation Distance

24 HR LOG

24 hr log	
Date	Nov 28/2021
Total	0 USG
Average	0.00 USG/m
Maximum	0.00 USG/m
Max Time	00:00:00
Minimum	0.00 USG/m
Min Time	00:00:00

Pressing LEFT from the Main Display will take you to the 24 HR LOG page. This page shows a summary view of the flow, starting with today's data. Pressing the DOWN or UP arrows will scroll to previous day's data. Up to 365 days will be stored. Newer data will overwrite the oldest, automatically, once the 365 day limit is reached. Press RIGHT, CHECK, or POWER to return to the Main Display.

PASSWORD

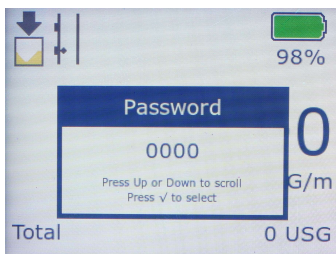

The password (a number from 0000 to 9999) prevents unauthorized access to the Main Menu for programming.

Pressing RIGHT from the Main Display will take you to the Password pop-out screen if the factory default Set Password parameter in the Special Functions menu was changed from 0000. If a password is required, the cursor will automatically be flashing on the leftmost numeral. Press either UP or DOWN to change the selection of that numeral, and RIGHT or LEFT to change the flashing cursor position. Press the CHECK button to accept the password and proceed to the Main Menu, or, press the POWER button to return to the Main Display.

IMPORTANT: If you have misplaced your password, contact Pulsar Measurement for assistance recovering it.

MAIN MENU

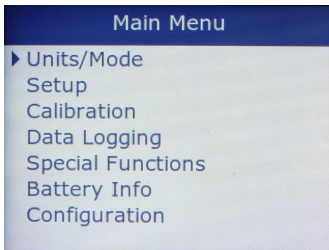

Pressing RIGHT from the Main Display (Set Password in Special Functions = 0000, default) or CHECK from the Password pop-out (Set Password ≠ 0000) will bring you to the Main Menu screen. The Main Menu functions to provide a simple, easy-to-understand starting point to navigate the programming parameters. The function of each page is described in subsequent sections. Use UP or DOWN to move the cursor position (▶) and RIGHT to navigate in-to the selected menu.

UNITS/MODE

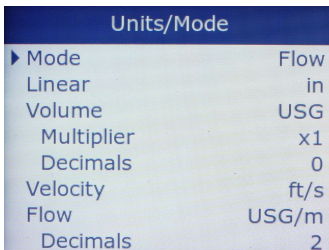

Pressing RIGHT on Units/Mode in the Main Menu will bring you to the Units/Mode programming sub-menu. In this menu you can use UP and DOWN to move the cursor, then RIGHT to change any value. When changing a value, a pop-up message will appear. Follow the on-screen prompts to change the value, CHECK to accept the change, or LEFT to cancel.

Mode – Select “Flow” (default) or “Velocity” for the mode of operation in the Main Display and Data Log.

Linear – Select “in” (inches, default), “ft” (feet), “mm” (millimeters), or “m” (meters) to define distances for pipe diameter, pipe wall thickness, separation distance, etc.

Volume – Select engineering units for the flow volume (totalizer) on the Main Display and Data Log. Options:

Option	Description	Option	Description
USG	US gallons (US default)	m³	cubic meters
USMG	US million gallons	L	liters (metric default)
IG	imperial gallons	bbl	barrels (1 bbl = 42 USG)
IMG	imperial million gallons	ft³	cubic feet

Multiplier – Select the multiplier for the Volume totalizer. As examples, Multipliers are used when resolution down to the singles place is not required, or when you don’t want to convert from gallons to thousands of gallons. Default = x1.

Decimals – Select the number of decimals to show for the Volume totalizer. Default = 0. Options = 0, 1, 2

Velocity – Select the units for flow velocity. US Default = ft/s. Metric Default = m/s. Options = ft/s or m/s.

UNITS/MODE (CONT.)

Units/Mode	
Mode	Flow
Linear	in
Volume	USG
Multiplier	x1
Decimals	0
Velocity	ft/s
Flow	USG/m
Decimals	2
Temperature	F

Flow – Select engineering units for the flow rate on the Main Display and Data Log. Options:

Option	Description	Option	Description
USG/d	US gallons per day	L/d	liters per day
USG/h	US gallons per hour	L/h	liters per hour
USG/m	US gallons per minute (US default)	L/m	liters per minute
USG/s	US gallons per second	L/s	liters per second (metric default)
ft³/d	cubic feet per day	m³/d	cubic meters per day
ft³/h	cubic feet per hour	m³/h	cubic meters per hour
ft³/m	cubic feet per minute	m³/m	cubic meters per minute
ft³/s	cubic feet per second	m³/s	cubic meters per second
bbl/d	barrels per day (1 bbl = 42 USG)	IG/d	imperial gallons per day
bbl/h	barrels per hour (1 bbl = 42 USG)	IG/h	imperial gallons per hour
bbl/m	barrels per minute (1 bbl = 42 USG)	IG/m	imperial gallons per minute
bbl/s	barrels per second (1 bbl = 42 USG)	IG/s	imperial gallons per second
USMG/d	US million gallons per day	IMG/d	imperial million gallons per day
USMG/h	US million gallons per hour	IMG/h	imperial million gallons per hour
USMG/m	US million gallons per minute	IMG/m	imperial million gallons per minute
USMG/s	US million gallons per second	IMG/s	imperial million gallons per second

Decimals - Select the number of decimals to show for the Flow rate. Default = 0. Options = 0, 1, 2

Temperature – Select the engineering units for defining the temperature of the fluid in the Setup menu. US default = F, Metric Default = C. Options = F or C.

SETUP

Setup	
▶ Sensor	SE16A
Angle	37
Fluid	Water
Temp Mode	Fixed
Temp	75.0 F
Pipe	PVC
OD	4.5000 in
Wall	0.2500 in
Lining	None
Crossings	2
Zero Tare	NO
Sens Space	2.850 in
Velocity	0.00 ft/s
Signal Strength	100%

Sensor – Select the sensor (transducer) type connected to the PTFM 6.1. Choices are SE16A, SE16B, and SE16C. Restoring default parameters does not **affect** this selection. When changing from one transducer to another, the Cal Constant in the Calibration menu will automatically update to the stored value for that sensor type. The following pop-up menu will appear when that occurs:

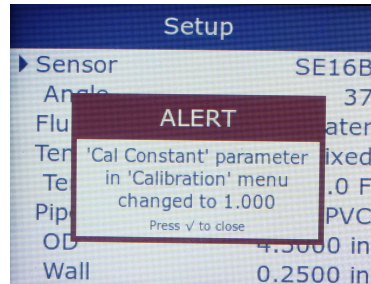

Angle – For SE16B only, select angle which matches the transducer pair connected to the **PTFM**. Options: 35, 37, 39, and 41.

Angle is determined by the part number on the SE16-B transducer label. For SE16A and SE16C, Angle should be 37.

Sensor Part Number	Corresponding Angle
SE16-B-35	35
SE16-B-37	37
SE16-B-39	39
SE16-B-41	41

Fluid – Select fluid type. Default = Water. Options = Water, Other, Propylene Glycol, Ethylene Glycol, Hydraulic Oil, and Diesel Oil.

Vel@25C - When Fluid = Other, enter the fluid sound velocity (speed of sound) at 25C from the reference table in this manual, or other reference. Engineering units will match Velocity selection in the Units/Mode menu.

dV/C – When Fluid = Other, enter the change in fluid sound velocity (speed of sound) per degree C, from the reference table in this manual, or other reference. Engineering units will match Velocity selection in the Units/Mode menu.

Temp Mode – Read-only. Temp Mode = Fixed.

Temp – Enter the temperature of the fluid. Engineering units will match the selection of Temperature in the Units/Mode menu.

Pipe – Select the pipe material. Default = PVC. Options = PVC, Poly HD, Poly LD, Nylon, Iron, FRP (Fiberglass), Ductile Iron, CPVC, Copper, Cast Iron, Carbon Steel, Brass, Aluminum, Acrylic, ABS, Other, Stainless 430, Stainless 410, Stainless 347, Stainless 316, Stainless 304, Stainless 303, Stainless 302, and Mild Steel.

OD – Enter the outside pipe diameter for the pipe the PTFM 6.1 transducers will be mounted on. The pipe OD should be as precise as possible. Refer to the pipe charts in this manual for the outside diameter of common pipe materials and schedules. If unsure of the pipe size for lookup on the reference charts, or the OD, use the included tape measure to measure the circumference of the pipe, then divide by 3.14 to calculate the OD. Default = 4.5 in (114.3 mm).

SETUP (CONT.)

Setup	
Sensor	SE16A
Angle	37
Fluid	Water
Temp Mode	Fixed
Temp	75.0 F
Pipe	PVC
OD	4.5000 in
Wall	0.2500 in
Lining	None
Crossings	2
Zero Tare	NO
Sens Space	2.850 in
Velocity	0.00 ft/s
Signal Strength	100%

Vel – When Pipe = Other, enter the shear-wave sound velocity (speed of sound) of the pipe the sensors will be mounted on. Engineering units match the selection of Velocity in the Units/Mode menu.

Wall – Enter the wall thickness of the pipe the sensors will be mounted on. The wall thickness should be entered as precise as possible. Refer to the pipe charts in this manual for wall thicknesses of common pipe materials and schedules. Default = 0.25 in (6.35 mm)

Lining – Select the liner on the inside of the pipe, if applicable. Default = None. Options = None, Tar Epoxy, Rubber, Mortar, Asb Cement, and Other.

Vel – When Lining = Other, enter the shear-wave sound velocity (speed of sound) of the liner material. Engineering units match the selection of Velocity in the Units/Mode menu.

Thickness – When Lining ≠ None, enter the thickness of the liner. The thickness of the liner should be entered as precise as possible. Refer to the pipe charts in this manual for liner thicknesses of common pipe materials and schedules where liners are used (e.g. Ductile Iron).

Crossings – Select the number of crossings for the ultrasound signal. Default = 2. Options = 1, 2, and 4.

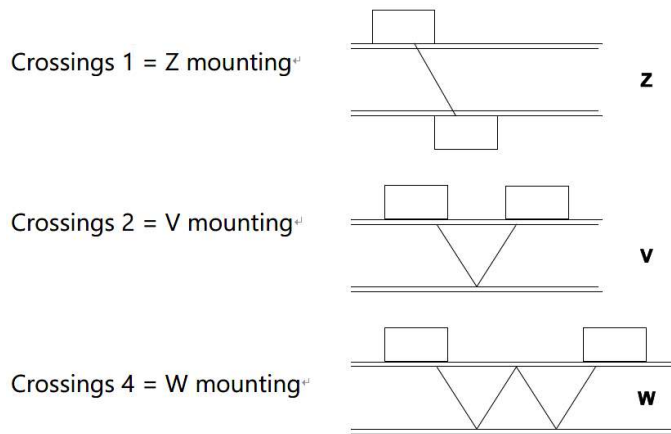

Nominal Pipe Size, Inches	Recommended Crossings, SE16A	Recommended Crossings, SE16B	Recommended Crossings, SE16C
0.5-1.5	4	N/A	N/A
2-3	2	2	N/A
4-6	2	2	2
8-10	N/A	2	2
12-24	N/A	2	2
26-48	N/A	1	2

Older pipes are often degraded, corroded, or scaled on the inside. These conditions can attenuate (weaken) the ultrasound as it bounces (2, 4 cross) or passes through (all crossings) the pipe wall. Consider starting at 2 crosses instead of 4, or 1 cross instead of 2 if you have a pipe known to be very old.

SETUP (CONT.)

Setup	
Sensor	SE16A
Angle	37
Fluid	Water
Temp Mode	Fixed
Temp	75.0 F
Pipe	PVC
OD	4.5000 in
Wall	0.2500 in
Lining	None
Crossings	2
Zero Tare	NO
Sens Space	2.850 in
Velocity	0.00 ft/s
Signal Strength	100%

Zero Tare – Select YES to tare (set-to-zero) the current measurement of the PTFM 6.1. While the zero flow stability of the PTFM 6.1 is very good, there might be instances where the reading does not repeatedly report 0 when there is confirmed 0 flow in the pipe. To properly use the Zero Tare, ensure that the flow in the pipe is actually stopped, and make sure the Min Flow is set to the flow rate equivalent of 0.1 ft/s (0.03 m/s) flow velocity in the programmed pipe size.

IMPORTANT: Setting a Zero Tare with flow in the pipe will create a significant accuracy issue. Correcting this problem requires re-establishing the Zero Tare with confirmed no flow in the pipe.

Sens Space – After selecting/entering the Sensor, Fluid, Temp, Pipe, Pipe OD, Pipe Wall, Lining, and Crossings, the PTFM 6.1 will calculate the geometry of the ideal sensor placement and provide the Sens Space. This is the ideal distance between the front of each sensor. When installing the sensors on the pipe, ensure that the distance between the transducers matches this Sens Space value.

For SE16A:

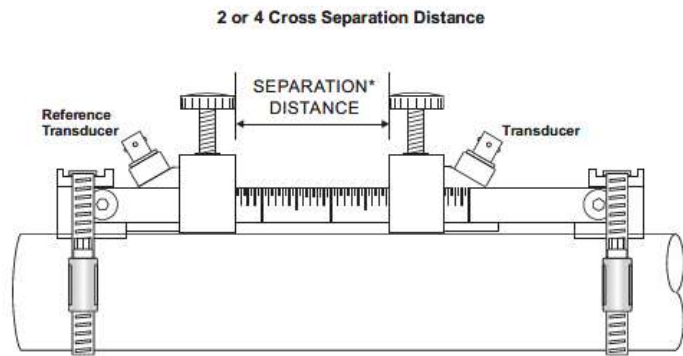

For SE16B:

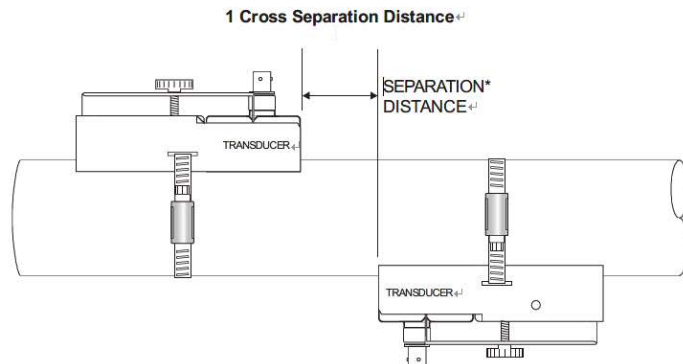
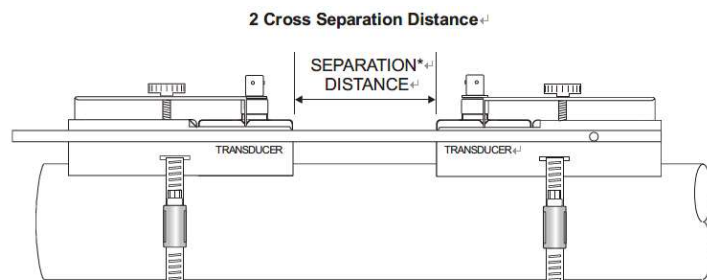

SETUP (CONT.)

Setup	
► Sensor	SE16A
Angle	37
Fluid	Water
Temp Mode	Fixed
Temp	75.0 F
Pipe	PVC
OD	4.5000 in
Wall	0.2500 in
Lining	None
Crossings	2
Zero Tare	NO
Sens Space	2.850 in
Velocity	0.00 ft/s
Signal Strength	100%

Sens Space (Cont.)

For SE16C:

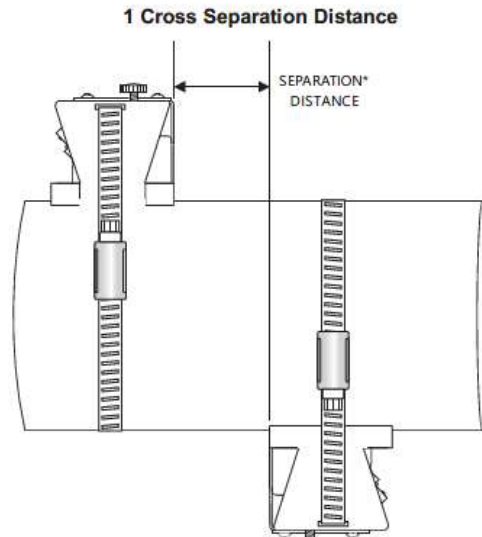
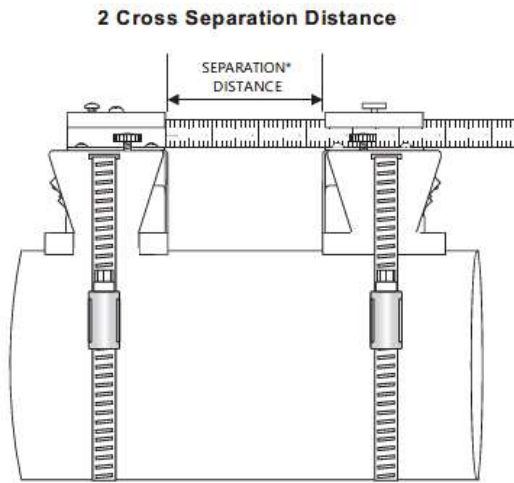

Signal Strength – After selecting/entering the required information for the Sens Spacing, and installing the transducers on the pipe full of water/other fluid, a Signal Strength will appear. The Signal Strength should be 100% under ideal operating conditions. Signal Strengths between 1-99% do not indicate that the meter is not reliable under the current installation, however, it will be more susceptible to complete signal loss should process conditions worsen from the current state. Diagnostics available in the Setup menu, and the Capture WF (Wave Form) parameter in the Special Functions menu can be used to help determine the exact cause of the less-than-ideal Signal Strength.

CALIBRATION

Calibration	
▶ Mode	Flow
LOS Time	10 sec
Min Flow	4.00 USG/m
Damping	
Mode	FIR
Percent	10%
Window	1.000 ft/s
Cal Constant	1.000

Mode – Read-only. Shows the selected Mode from the Units/Mode menu.

LOS Time – Enter the Loss of Signal (LOS) Time to suppress intermittent loss of signal. As an example: systems with high concentrations of undissolved gasses will cause fluctuations in signal strength when the gasses move past the ultrasonic signal. If a complete loss of signal is experienced, the PTFM 6.1 will hold the last valid reading for the duration of the LOS Time. If the signal strength returns before the LOS Time is expired, the meter will return to normal operation automatically. If signal strength does not return after the LOS Time has expired, then the meter will report zero flow on the LCD display and produce a Low Signal alarm. Default = 10 seconds. Options = 0-99 sec.

Min Flow – Enter the Min Flow cutoff, which means any flow rate below Min Flow measured by the PTFM 6.1 will result in 0 flow on the display and data log. Default = 4 GPM (0.25 L/s) for a 4 in (100 mm) nominal pipe, which is the approximately equal to 0.1 ft/s (0.03 m/s) flow velocity. This is the suggested flow velocity to be used for Min Flow values in other nominal pipe sizes. Setting the Min Flow to 0 will result in small measurements to display and accumulate on the totalizer, so this should be avoided. It is possible to set the Min Flow below a flow velocity of 0.1 ft/s, but a Zero Tare in the Setup menu may need to be invoked to avoid false readings at zero.

Damping Mode - Select OFF, FIR (Default), or LOW PASS. When measured flows are outside the Window of the previous measurement, the FIR filter will reduce the damping average so that a fast response can be made to the sudden change in flow rate. The LOW PASS filter will ignore measured flow rates outside the window, while holding the previous measurement, until there are enough measurements made outside the window to cause a step-response to the most current measured value. While measured flows are within the window of the previous measurement, both the FIR and LOW PASS filter behave the same.

Damping Percent - Higher percentages increase the number of measurements which are averaged together to produce a stable flow reading. Higher percentages also increase the time it takes for the meter to make a step-response to the measured flow rate outside the window in the LOW PASS Mode. Default = 10%. Options = 0-100%.

Damping Window - Defines the window around the running average, in units of Velocity set in the Units/Mode menu. Measurements made inside the window are added to the running average, and measurements outside the window effect the response of the meter as described in the Mode section. Default = 1 ft/s (0.3 m/s). Options = 0-20 ft/s (6.096 m/s).

Cal Constant – Calibration constant defined when the PTFM 6.1 was calibrated at the factory. Specific to the sensor (transducer) model selected in the Setup menu. When changing the Sensor model, a pop-up menu **appears** notifying the user that this value automatically changed to the last stored value. Should this value accidentally be changed, reference the calibration certificate included with the PTFM in order to determine the factory Cal Constant.

DATA LOGGING

Data Logging	
Log Site ID	00
Logging Mode	Flow
File Format	.LG2
Date	Nov 29/2021
Time	12:50:21
Interval	30 sec
Data Log	Logging
Log in Standby	NO

Log Site ID – Enter a number from 00 (Default) to 99. The Site ID will become part of the filename for any file downloaded from the PTFM, to help distinguish from other installation sites. This parameter can be changed at any time.

Logging Mode – Select the logging mode. Default = Flow. Options = Flow, Velocity. This setting cannot be changed if Data Log = Logging. Either STOP or DELETE the Data Log to change the Logging Mode.

File Format – Choose the file format for downloading the log. Default = .LG2. Options = .LG2, .CSV. LG2 format is used for viewing the logged data with the free Greyline Logger Software. CSV format is used for importing into spreadsheet software like Microsoft Excel. This parameter can be changed at any time.

Date – Select the current Date in MMM/DD/YYYY format. It is strongly suggested that the Data Log is deleted and restarted after changing the Date, Time, and Interval.

Time – Select the current Time in HH:MM:SS format. Options: 00:00:00-23:59:59. **It is** strongly suggested that the Data Log is deleted and restarted after changing the Date, Time, and Interval.

Interval – Select the interval between samples to be stored to the data log. Smaller intervals provide better resolution and understanding of changes in flow rate or velocity over time, at the expense of file size and storage capacity. The PTFM has capacity for approximately 3.8 years of continuous logged data at a 10 second interval. Default = 30 sec. Options = 10 sec, 30 sec, 1 min, 2 min, 5 min, 10 min, 15 min, 30 min, and 60 min.

Data Log – Shows the status of the Data Log, and is used to change the status. Logging = Data Log is active. Stopped = Data Log is stopped. Delete = deleted the Data Log and sets the status to Stopped. Start = starts the Data Log and sets the status to Logging. Stop = stops the Data Log and sets the status to Stopped.

Log In Standby – Currently not used.

RETRIEVING LOG FILE

Plug a USB-C drive (one is included with the PTFM 6.1) into the USB-C port on the bottom the electronics enclosure. The display will show a downloading icon, then a check mark on the icon when the download is complete. When the check mark appears, the USB-C drive can be removed:



The downloaded file name will appear in this format: **PTFM_0A.LG2**. The "0" will change, based on the Log Site ID parameter. The "A" will increment: B, C, etc.; with each subsequent download of the data log.

IMPORTANT: Downloading the file in .LG2 format will take approximately 2.75 minutes each 1% log used. Downloading in .CSV format will take approximately 5.7 minutes each 1% log used.

SPECIAL FUNCTIONS

Special Functions	
▶ Language	English
Backlight	Very High
Mode	Fixed
Reset Totalizer	NO
Neg.Totals	NO
Rev.Flow	Off
Restore Defaults	NO
Capture Parameters	NO
Capture Waveform	NO
Set Password	0000

Language – Select the language for the user interface. Options = English (Default), Spanish, or French.

Backlight – Select the backlight level, which effects brightness for readability in sunlight, as well as energy usage. Options = Very Low, Low, Medium, High (Default), and Very High. There is approximately 100mA difference in operating current between the Very Low and Very High brightness levels.

Mode – Select the mode for the backlight level. Options = Fixed (Default), Dark 10 sec, Dark 30 sec, Dark 60 sec. The “Dark” options will set the backlight to the level selected in the Backlight parameter when any button is pressed, then go to dark (slightly less brightness compared to Backlight = Very Low), until a button is pressed again. When in a “Dark” mode, the first button press after the screen has gone dark will set the brightness to the Backlight level.

Reset Totalizer – Selecting Yes will reset the volume totalizer on the Main Display to 0. Choose No or press the LEFT arrow to exit this menu option without making a change.

Neg. Totals – This parameter turns the totalizer on the Main Display into a NET totalizer. Positive flow will increment the totalizer, and negative flows will decrement the totalizer. Options = No (Default), Yes.

Rev. Flow – This parameter enables the flow direction indication on the PTFM 6.1. When flow velocity moves in the direction of upstream to downstream transducer, that is positive flow when Rev. Flow = On. When flow velocity moves in the direction of downstream to upstream transducer, that is negative flow when Rev. Flow = On. Rev. Flow = Invert inverts these directions. Rev. Flow = Off (Default) ignores transducer orientation, such that all flows are positive (absolute value).

Restore Defaults – The parameter restores the configuration settings to the factory default values. Options = US, Metr. The “US” option will set the units in the Units/Mode menu to US/Imperial defaults, while the “Metr” option will set them to the Metric defaults. This parameter does not change any factory calibration settings, like the Cal Constant in the Calibration menu. Nor does it change any settings in the Data Logging menu.

Capture Parameter – Choose Yes to download the programming parameters and current measurements to a USB drive. After selecting Yes, the meter will take a couple of seconds to package the parameters, then prompt you to Insert USB (flashing). Insert your USB-C drive when this prompt appears, and the transfer will occur automatically while displaying Saving (flashing). Once the save is complete, the meter will display Done (static). Remove the USB-C drive and the pop-out menu automatically clears.

SPECIAL FUNCTIONS (Cont.)

Special Functions	
Language	English
Backlight Mode	Very High Fixed
Reset Totalizer	NO
Neg.Totals	NO
Rev.Flow	Off
Restore Defaults	NO
Capture Parameters	NO
Capture Waveform	NO
Set Password	0000

Capture Waveform – Choose Yes to capture and display the waveform on the display of the PTFM. After selecting Yes, Working (blinking) will appear, and then the waveform will appear on the screen, an example shown below. This will only work when the sensors are connected properly, and no “Sensor Short” or “Sensor Open” message appears on the Messages page.

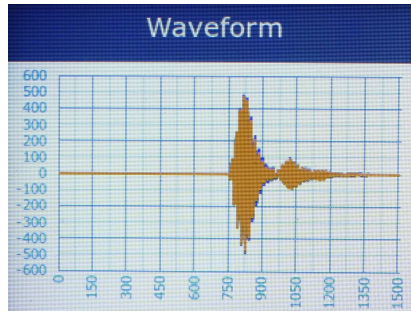

Pressing the UP arrow button while in this view will allow you to zoom in for more resolution. You will zoom in at the 750 count mark on the x-axis, so if the waveform is positioned closer to the edges of the window, you will need to then use the LEFT or RIGHT arrow buttons to scroll when zoomed in. Press the DOWN arrow to zoom back out. Zoom levels:

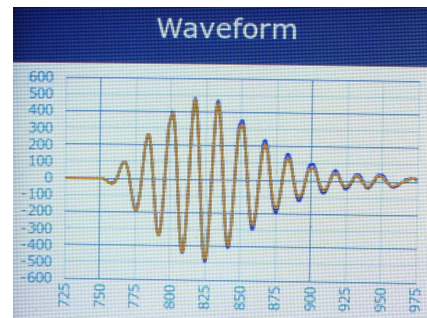
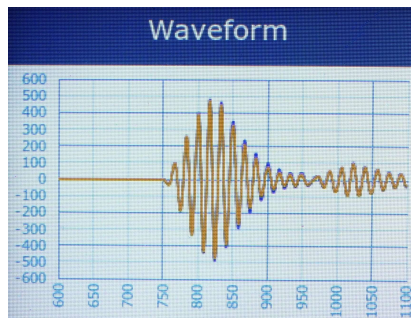

If you press the CHECK button while on the Waveform screen, a pop-up message will appear, providing the following options: Exit, Recapture, Save. Choosing Exit will return you to the Special Functions menu. Recapture will take another waveform at that instant and display it on the screen. Save will take the waveform and package it for download to a USB-C drive. When prompted on the screen via Insert USB, insert your USB-C drive into the meter, and the PTFM will save the file. We will occasionally ask for this file in order to help diagnose measurement questions.

Set Password – The default password of 0000 allows for unrestricted access to the programming Main Menu and its sub-menus. Change the password to restrict access for those who do not know the password.

BATTERY INFO

Battery Info	
Battery Voltage	4.095 V
Battery Current	-405.9 mA
Battery Level	98%
USB Voltage	3.200 V
USB Current	0 mA
Charge Current	0 mA
USB Device	None

The Battery Info page is used for diagnostic purposes, and is not used for any configuration of meter behavior.

Battery Voltage – Shows the battery voltage in volts (V).

Battery Current – Shows the charge (positive) or discharge (negative) current in milliamperes (mA).

Battery Level – Shows the battery fuel gauge charge percent. Matches the percentage shown on the Main Display and Messages page.

USB Voltage – Shows the voltage on the USB connector. Typically 3.2 V when no charger is connected, and 5.0 V when a charger is connected.

USB Current – Shows the current from the external USB-C charger.

Charge Current – Shows the current into the battery.

USB Device – Shows the state of the USB connection: None, Charger, Drive

CONFIGURATION

Configuration	
Serial#	000012345
Utility	1.1.11.g
Transit Time	2.7.1
Bootloader	1.2

The Configuration page shows the serial number of the PTFM, and the firmware versions of the utility board, transit time board, and bootloader. Pulsar may ask for this information to help diagnose measurement questions.

SENSOR MOUNTING LOCATION

The position of the sensor is one of the most important considerations for accurate flow measurement. The same location guidelines apply to Transit Time as they do for most other flow meter technologies.

VERTICAL OR HORIZONTAL PIPE - Vertical pipe runs are acceptable, and the transducers can be mounted in any orientation around the pipe. Downward flow should be avoided in case the pipe becomes partially filled or aerated. On horizontal pipes and liquids with high concentrations of gas or solids, the sensors should be mounted on the side (1 to 5 o'clock positions) to avoid concentrations of gas at the top of the pipe, or solids at the bottom.

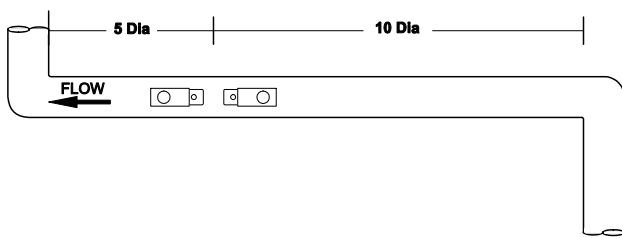
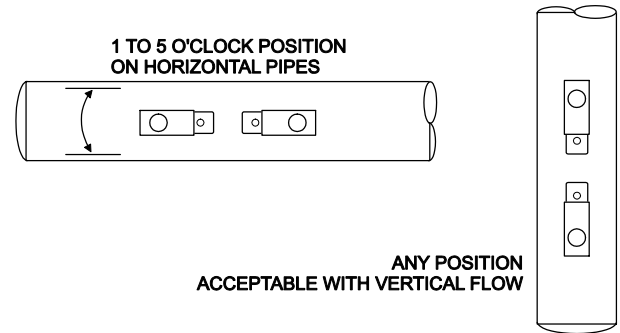

STRAIGHT RUN REQUIREMENTS – For best results, the transducers must be installed on a straight run of pipe, free of bends, tees, valves, transitions, insertion probes and obstructions of any kind. **For most installations, ten straight unobstructed pipe diameters upstream and five diameters downstream of the transducers is the minimum recommended distance for proper operation.** Additional considerations are outlined below.

- Do not, if possible, install the transducers downstream from a throttling valve, a mixing tank, the discharge of a positive displacement pump or any other equipment that could possibly aerate the liquid. The best location will be as free as possible from flow disturbances, vibration, sources of heat, noise, or radiated energy.
- Avoid mounting the transducers on a section of pipe with any external scale. Remove all scale, rust, loose paint, etc., from the location prior to mounting the transducers. A sanding block is included with every meter to facilitate proper pipe preparation.
- Do not mount the transducers on a surface aberration (pipe seam, etc.).
- Do not mount transducers from different ultrasonic flow meters on the same pipe.
- Do not run the transducer triaxial cables in common bundles with cables from other instrumentation. You can run these cables through a common conduit **ONLY** if they originate at the same flow meter.
- Never mount transducers under water.

IMPORTANT NOTE: In some cases, longer straight runs may be necessary where the transducers are placed downstream from devices which cause unusual flow profile disruptions or swirl. For example: modulating valves, or two elbows in close proximity and out of plane. The position of the sensor is one of the most important considerations for accurate flow measurement. The same location guidelines apply to Transit Time as most other flow meter technologies.

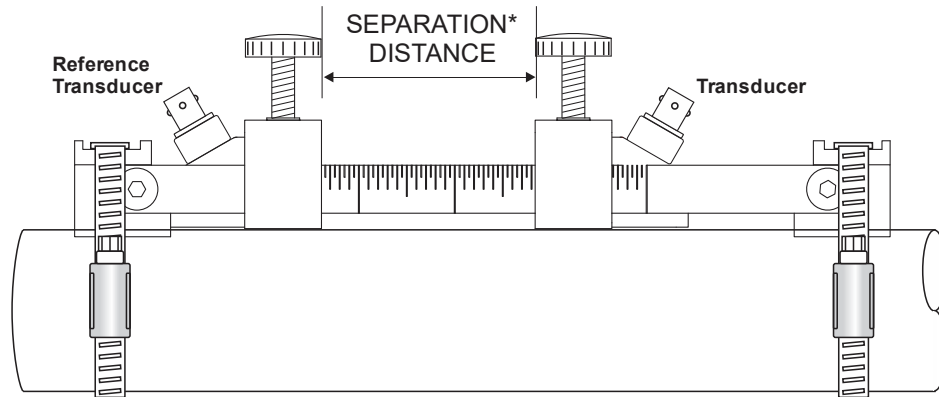
TYPICAL SE16A SENSOR INSTALLATION**2 or 4 Cross Separation Distance**

* Shown in 'Set up' menu after sensor, fluid and pipe parameters are entered.

Separation distance is measured from transducer face to transducer face.
Reference transducer is placed flush to bracket.

Mount the supplied SE16A Series Transducers on pipes 0.5" / 15 mm OD or larger.

Transducers should be installed with the cable connections pointed away from each other.

TYPICAL SE16B SENSOR INSTALLATION

2 Cross Separation Distance

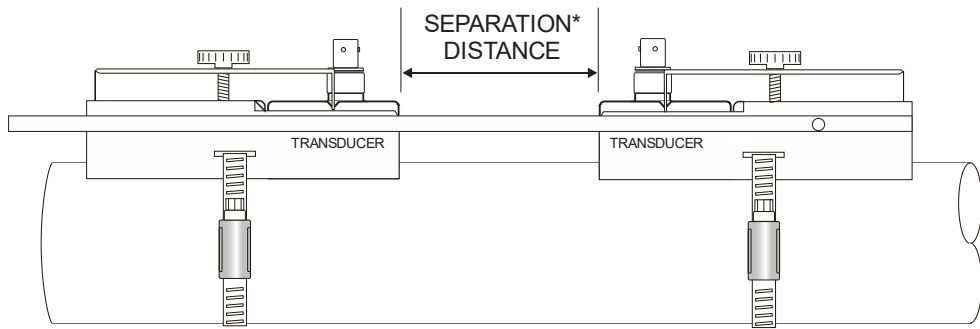

1 Cross Separation Distance

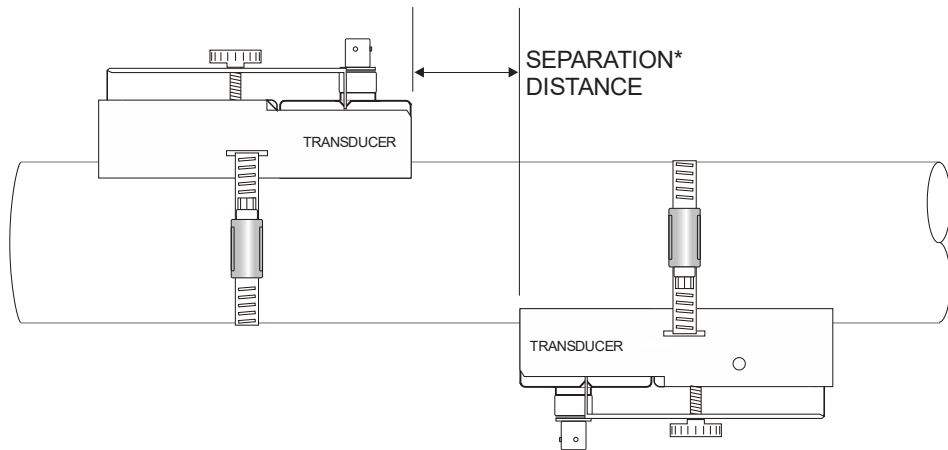

* Shown in 'Set up' menu after sensor, fluid and pipe parameters are entered.

TMK-B1 transducer mounting kit shown. Sensor spacing method is consistent with TMK-B21 and TMK-B22 kits, but the brackets will be different.

Arrows on top of transducers should be pointed towards each other:

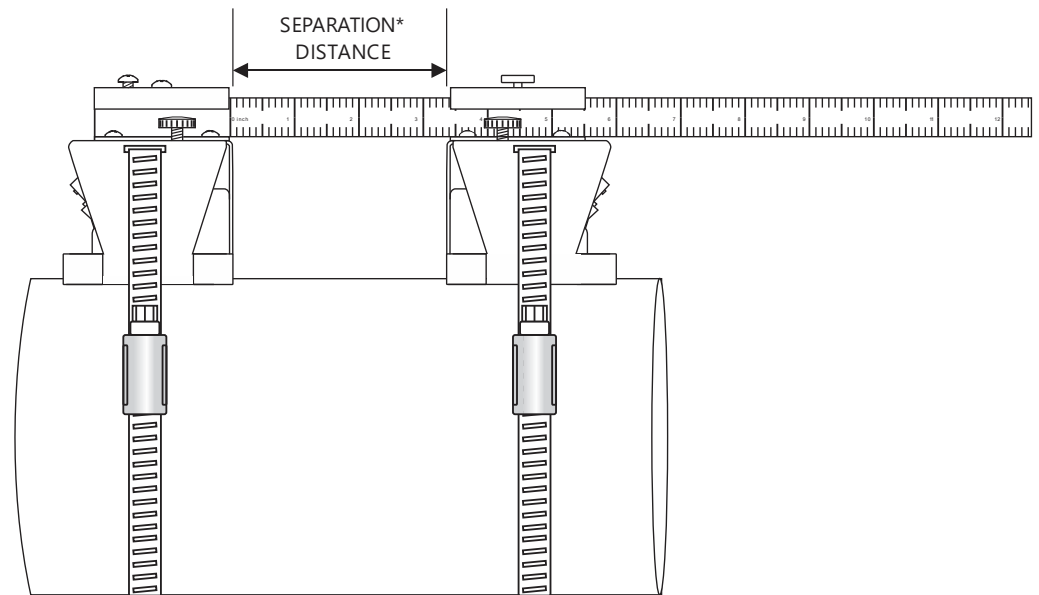
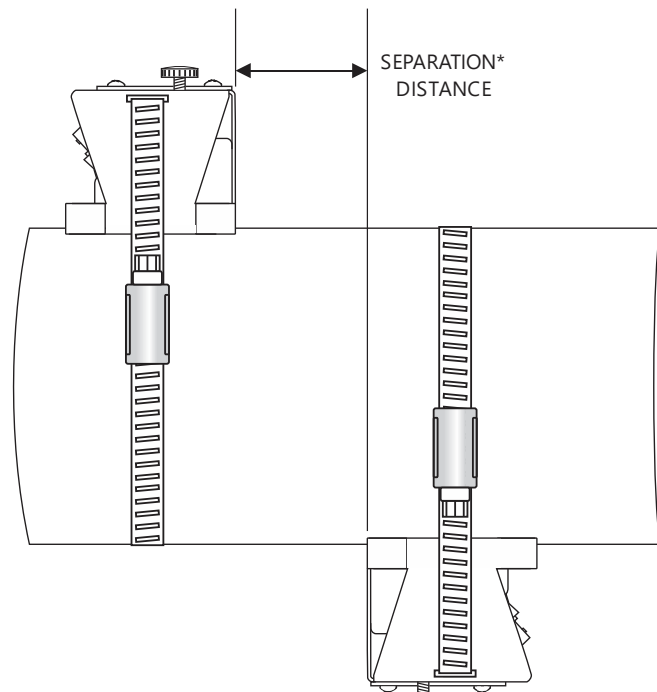
TYPICAL SE16C SENSOR INSTALLATION**2 Cross Separation Distance****1 Cross Separation Distance**

*Shown in 'Set up' menu after sensor, fluid and pipe parameters are entered.

TMK-C1 transducer mounting kit shown. Sensor spacing method is consistent with TMK-C1 or TMK-C2 kits.

Angles on the back of the transducers should be facing away from each other.

SE16A Pipe Preparation and Bracket Mounting

Prepare an area 2" wide by 10" long (50mm x 250mm) for the track mounting bracket by removing loose paint, scale, and rust. The objective of site preparation is to eliminate any discontinuity between the sensor and the pipe wall, which would prevent acoustical coupling. A sanding block is included with every meter to facilitate proper pipe preparation.

A Sensor Mounting Kit is supplied with each flow meter. It includes recommended coupling compound, and a stainless-steel mounting bracket with adjustable pipe straps. Use the built-in ruler to easily measure separation distance between transducer faces.

IMPORTANT: The SE16A transit-time transducers should be installed with the cable connections pointed away from each other, as shown in the drawing below.

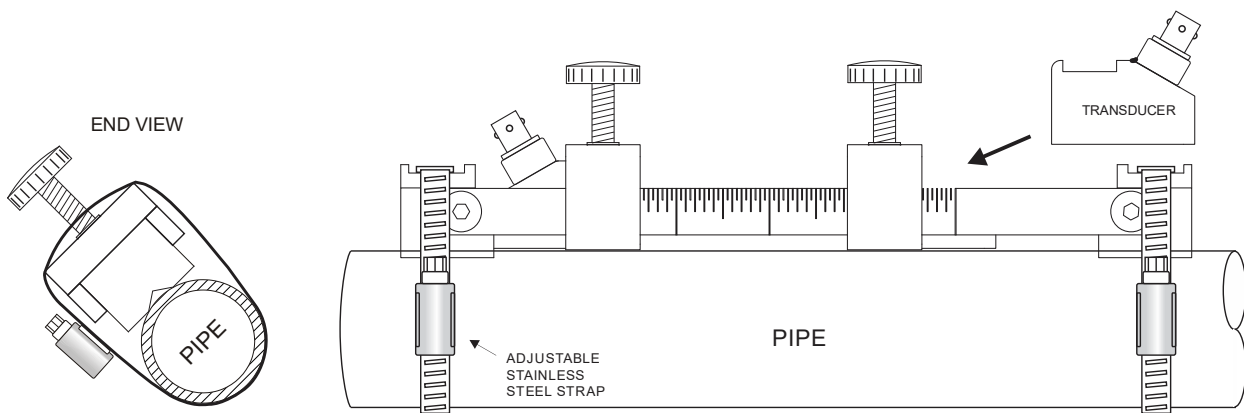

Mount the supplied SE16A Series Transducers on pipes 0.5" / 15 mm OD or larger.

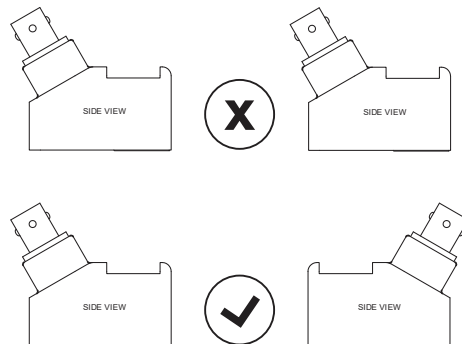

SE16B Pipe Preparation and Bracket Mounting

Prepare an area 2" wide by 4" long (50mm x 100mm) for each sensor bonding by removing loose paint, scale and rust. The objective of site preparation is to eliminate any discontinuity between the sensor and the pipe wall, which would prevent acoustical coupling. A sanding block is included with every meter to facilitate proper pipe preparation.

A Sensor Mounting Kit is supplied with each flow meter. It includes recommended coupling compound, and a stainless steel mounting bracket with adjustable pipe straps. Use the Alignment Bar (included) to align sensor brackets for V and W mode mounting.

IMPORTANT: The SE16B transit-time transducers have arrows on the top of them. These should face each other at installation.

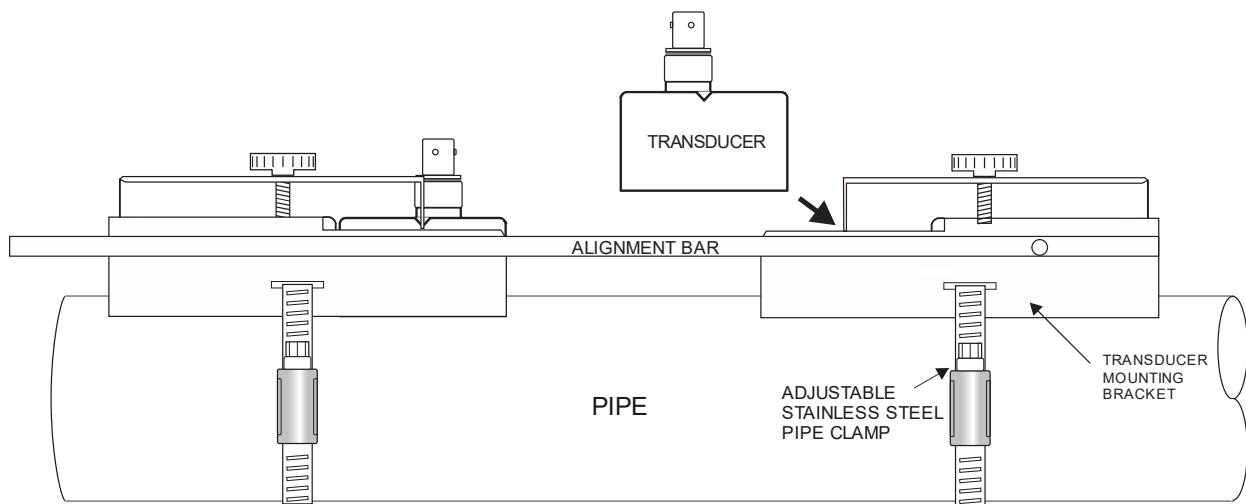

Mount the Mounting Bracket as illustrated on pipes 2" / 50 mm OD or larger. Stainless steel bands are included for mounting on pipes up to 30" / 750 mm OD.

Additional stainless steel bands (provided by customer) may be combined to mount on larger pipes. TMK-B1 Installation Kit shown.



SE16C Pipe Preparation and Bracket Mounting

Prepare an area 2" wide by 4" long (50mm x 100mm) for each sensor bonding by removing loose paint, scale and rust. The objective of site preparation is to eliminate any discontinuity between the sensor and the pipe wall, which would prevent acoustical coupling. A sanding block is included with every meter to facilitate proper pipe preparation.

A Sensor Mounting Kit is supplied with each flow meter. It includes recommended coupling compound, and a stainless-steel mounting bracket with adjustable pipe straps. Use the Alignment Bar (included) to align sensor brackets for V and W mode mounting.

IMPORTANT: The SE16C transit-time transducers do not have arrows on top of them. The cable connection points should be facing away from each other at installation.

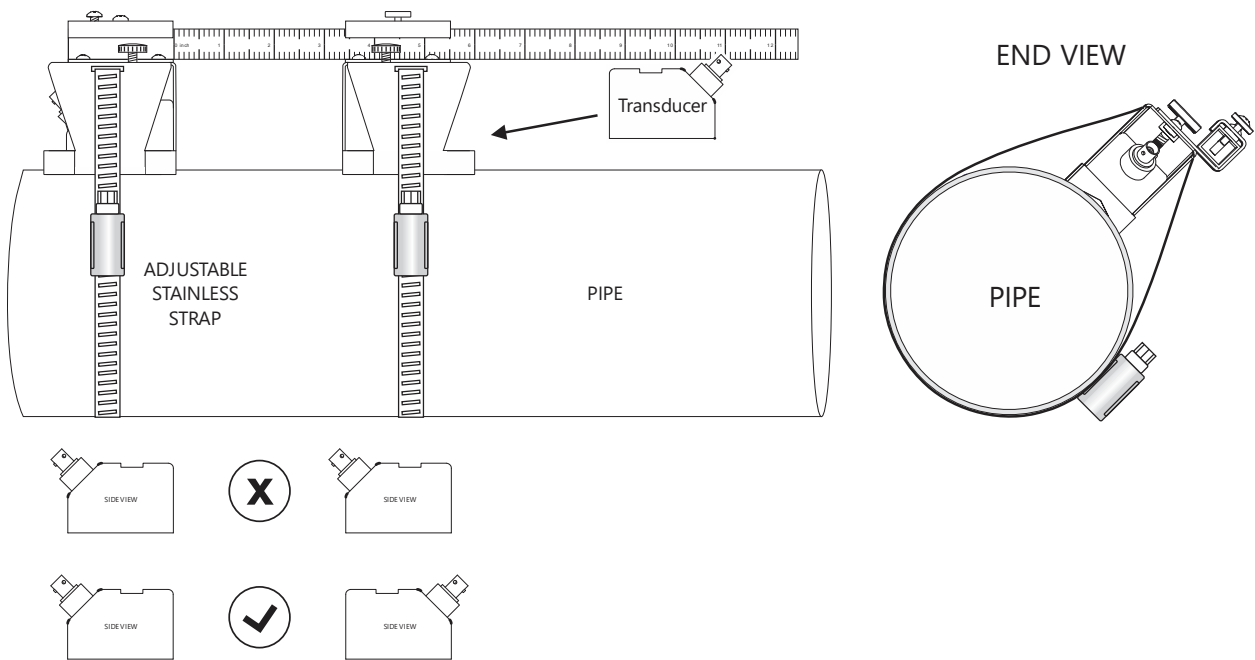

SENSOR COUPLING

For permanent bonding, the following are recommended:

- 1 Super Lube® (supplied)

Additional supply: order Option CC-SL30 or your local home improvement store.

For temporary bonding, the following are recommended:

- 2) Electrocardiograph gel
- 3) Petroleum gel (Vaseline)

DO NOT USE: Silicon RTV caulking compound (silicon rubber).

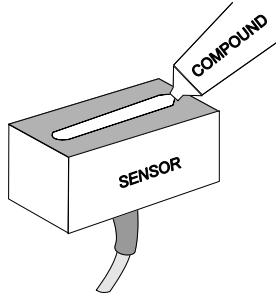

Use the pipe clamp and alignment bar (supplied) as illustrated on previous page. Apply Super Lube® to the bottom of the sensor. A bead, similar to toothpaste on a toothbrush, is ideal. Do not overtighten (crush the sensor).

The sensor must be fixed securely to the pipe with coupling material between the sensor face and the pipe. Sensor installation with excessive coupling compound can result in gaps or voids in the coupling and cause errors or loss of signal. Insufficient coupling compound will create similar conditions.

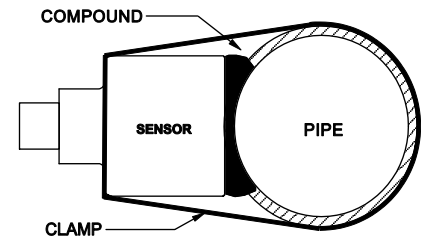

Over time temporary coupling compounds (e.g. Petroleum Gel) may gradually sag away from the sensor resulting in reduced signal strength and finally complete loss of signal. Warm temperatures, moisture and vibration will accelerate this process. Coupling tape and Super Lube® as supplied with the PTFM 6.1 (and available from Pulsar Measurement or home improvement stores) is recommended for permanent installations.

SENSOR MOUNTING/COUPLING RECOMMENDATIONS

BAD

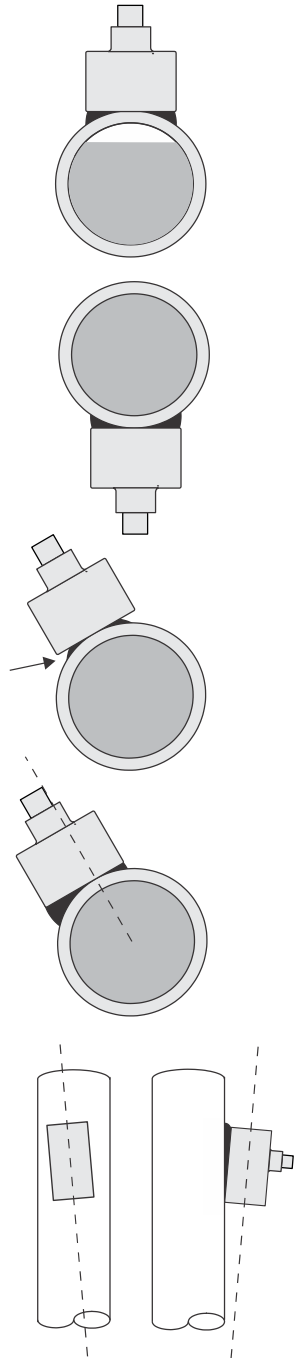

GOOD

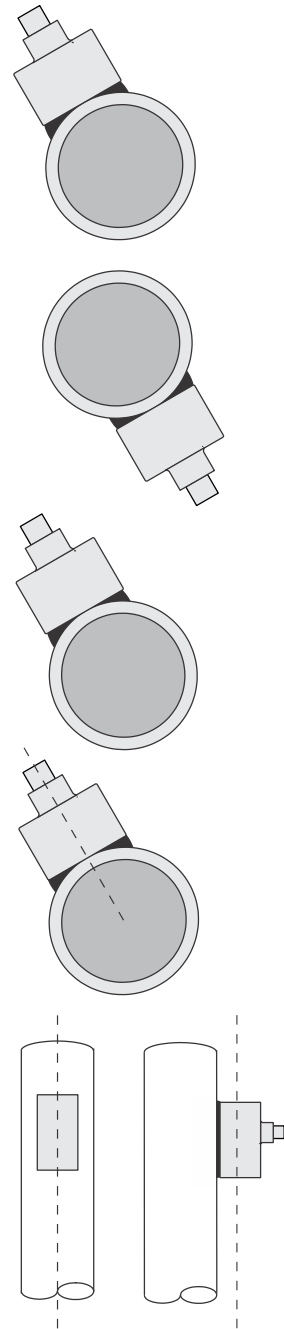

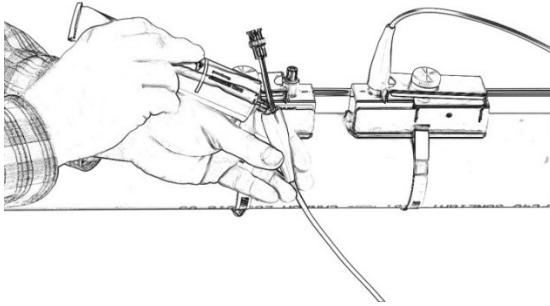
TRANSDUCER INSTALLATION IN WET LOCATIONS

The transit time transducers are rated for accidental submersion up to 10 psi (0.75 bar). The flow meter will continue to operate and measure flow accurately during periods of submergence. Plastic seal jackets on the cables, as well as the BNC connectors, must be filled with coupling compound to provide additional moisture protection for the BNC cable connectors.

COMMON QUESTIONS AND ANSWERS

The pipe vibrates. Will it affect the flow meter?

Common vibration frequencies are far lower than the sonic frequencies used by the transit time flow meter, and will not normally affect accuracy or performance. However, with applications where very weak signal is present (when sensitivity is adjusted to maximum and signal strength is low), accuracy may be affected by pipe vibration, or the flow meter may show readings under no-flow conditions. Attempt to relocate the sensor on a pipe section where vibration is reduced, or arrange pipe mounting brackets to reduce vibration at the sensor mounting location.

The flow meter must be installed in a high noise environment. Will this affect operation?

Pulsar Measurement's transit time flow meters are designed to discriminate between environmental noise and the transit time signal. High noise environments may affect the flow meter's performance where low signal strength and/or low flow velocities are being measured. Relocate the sensor in a quieter environment if possible.

Will pipe corrosion affect accuracy of the flow meter?

Yes. Rust, loose paint etc. must be removed from the outside of the pipe to provide a clean mounting position when installing a transit time sensor. Severe corrosion/oxidation on the inside of the pipe may prevent the transit time signal from penetrating into the flow. If the pipe cannot be cleaned, a spool piece (PVC recommended) should be installed for sensor mounting.

What effect do pipe liners have on the flow meter?

Typically, there is little to no effect of a well-bonded liner such as cement, epoxy, or tar inside the pipe. Should there be an air gap between loose insertion liners and the pipe wall, this will prevent the transit time signal from entering the fluid. An on-site test is recommended to determine if the application is suitable for a transit time flow meter when an unbonded liner is possible.

Why is transit time recommended for clean liquids?

The transit time sensors transmit sound across the flow stream in order to measure sound velocity and therefore requires a fluid medium that does not significantly attenuate the ultrasonic signal as it travels through it. The transit time system will not function when there is high volume of solids or aeration. As a guideline, Pulsar Measurement transit time flow meters are recommended for clean liquids with solids or bubbles content less than 2% by volume. Most applications such as water, chemicals and oils will meet this minimum requirement. When in doubt, an on-site test is recommended to determine if the application is suitable for transit time.

Can the sensors be submerged in water?

Yes, for short periods of time or by accident, but it is not recommended for continuous operation. The sensor is constructed to withstand submersion to 1m depth for 30 minutes without damage. Plastic seal jackets and BNC connectors on the sensor cables should be filled with coupling compound to provide additional moisture protection for the BNC connectors.

What is the purpose of the Signal Strength Display?

The primary function of the signal strength display is to assist as feedback when mounting sensors. Signal Strength can also be a useful diagnostics tool when troubleshooting problems with an installation. A signal strength less than 100% may indicate a problem with the installation or other issues such as a mis-programmed pipe size, pipe material, fluid type or temperature, or wrong transducer spacing. A signal strength less than 100% may also simply indicate a lot of aeration, or deteriorated pipe. Consideration should be made to use a 1 cross installation in such a case.

Does the PTFM 6.1 require periodic recalibration?

PTFM 6.1 calibration does not normally drift over time. Pulsar offers a calibration service to verify instrument accuracy. Please use the contact information on the subsequent pages to set up a RMA.

ISO 9001 or similar quality management systems may require periodic and verifiable recalibration of flow meters. PTFM 6.1 Flow Meters may be returned to Pulsar Measurement for factory calibration and issue of a new NIST traceable certificate.

Can the internal batteries be replaced?

The built-in rechargeable LiPo battery pack is not user-serviceable. The meter should be returned to Pulsar Measurement for battery service. Significant harm could occur to the user or property if the lithium battery is damaged, so do not attempt to operate the meter outside of our recommendations.

APPLICATIONS HOTLINE

For applications assistance, advice or information on any Pulsar Measurement instrument contact your Sales Representative, write to Pulsar Measurement or phone the Applications Hotline below:

COUNTRY	TEL	FAX	E-MAIL	ADDRESS
United States	888-473-9546	613-938-4857	northamerica@pulsarmeasurement.com	11451 Belcher Road South Largo, FL 33773
Canada	855-300-9151	613-938-4857	northamerica@pulsarmeasurement.com	16456 Sixsmith Drive Long Sault, Ont. K0C 1P0
UK	+44 (0) 1684 891371	+44 (0) 1684 575985	europa@pulsarmeasurement.com	Cardinal Building Enigma Commercial Centre Sandy's Road, Malvern WR14 1JJ
Asia	N/A	N/A	asiapacific@pulsarmeasurement.com	34-1A, Jalan 10A/KU5 Taman Aman Perdana 41050 Klang, Selangor, Malaysia
Oceania	+61 428 692 274	N/A	oceania@pulsarmeasurement.com	N/A

PRODUCT RETURN PROCEDURE

Instruments may be returned to Pulsar Measurement for service or warranty repair.

1 Obtain an RMA Number from Pulsar Measurement -

Before shipping a product to the factory please contact Pulsar Measurement by telephone, fax or email to obtain an RMA number (Returned Merchandise Authorization). This ensures fast service and correct billing or credit.

When you contact Pulsar Measurement please have the following information available:

1. Model number / Software Version
2. Serial number
3. Date of Purchase
4. Reason for return (description of fault or modification required)
5. Your name, company name, address and phone number

2 Clean the Sensor/Product -

Important: unclean products will not be serviced and will be returned to the sender at their expense.

1. Rinse sensor and cable to remove debris.
2. If sensor has been exposed to sewage, immerse both sensor and cable in a solution of 1 part household bleach (Javex, Clorox etc.) to 20 parts water for 5 minutes. Important: do not immerse open end of sensor cable.
3. Dry with paper towels and pack sensor and cable in a sealed plastic bag.
4. Wipe the outside of the enclosure to remove dirt or deposits.
5. Return to Pulsar Measurement for service.

LIMITED WARRANTY

Pulsar Measurement warrants, to the original purchaser, its products to be free from defects in material and workmanship for a period of two years from date of invoice. Pulsar Measurement will replace or repair, free of charge, any Pulsar product if it has been proven to be defective within the warranty period. This warranty does not cover any expenses incurred in the removal and re-installation of the product.

If a product manufactured by Pulsar should prove defective within the first year, return it freight prepaid to Pulsar Measurement along with a copy of your invoice.

This warranty does not cover damages due to improper installation or handling, acts of nature, or unauthorized service. Modifications to or tampering with any part shall void this warranty. This warranty does not cover any equipment used in connection with the product or consequential damages due to a defect in the product.

All implied warranties are limited to the duration of this warranty. This is the complete warranty by Pulsar Measurement and no other warranty is valid against Pulsar Measurement. Some states do not allow limitations on how long an implied warranty lasts or limitation of incidental or consequential damages, so the above limitations or exclusions may not apply to you.

This warranty gives you specific legal rights, and you may also have other rights which vary from state to state.

Pulsar Measurement

SPECIFICATIONS

General Specifications

Operating Parameters:	For clean fluids in full pipes, with typically less than 2% by-volume concentration of solids or bubbles. Also suitable for wastewater or sludge flows with low solids concentration.
Configuration:	Built-in 5-button keypad interface with English, French, and Spanish menu language selection
Electronics Enclosure:	IP67 when transducer cables connected. IP65 when transducers cables not connected. Aluminum enclosure with silicone protective end covers.
Flow Velocity Range:	±0.03 m/s to 12.2 m/s (±0.1 to 40 ft/s)
Accuracy:	±1% of reading or ±0.0046 m/s (±0.015 ft/s), whichever is greater Repeatability & Linearity: ±0.25%
Power Input:	Built-in rechargeable lithium polymer battery for up to 15 hours continuous operation External mains to USB-C charger with 100-240V AC, 50-60Hz, 0.6A input; and 5.0V DC, 3A, 15W output
Display:	Color TFT LCD display, IPS type, 2.8" screen size, 320 x 240 resolution, 500 NITS brightness, super wide view
Outputs:	Log files, daily log files, parameter settings files, and waveform capture files via USB-C flash drive (included)
Data Logger:	12 million point capacity, configurable for velocity or flow rate, date and time stamped, configurable format for Greyline Logger Software (LG2) or CSV, available intervals of 10 s, 30 s, 1 min, 2 min, 5 min, 10 min, 15 min, 30 min, and 1 hr
PC Software:	Free Greyline Logger Software for Windows. For display, manipulation, analysis, and exporting of data.
Operating Temp. (Electronics):	-20 °C to +60 °C (-5 °F to +140 °F)
Carry Case:	IP67, with protective molded foam, with room for all transducer sizes and installation hardware
Language Selection:	English, French, Spanish
Approvals:	CE
Approximate Shipping Weight:	SE16A or SE16B only: 5.5 kg (12 lb) All transducers: 11.3 kg (25 lb)

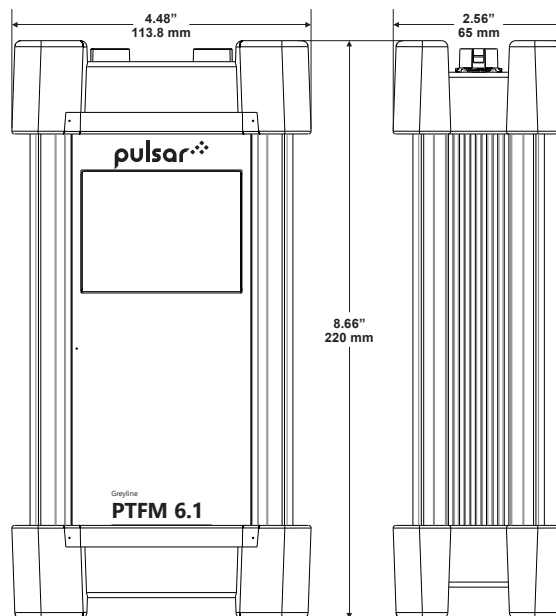

Transducer Specifications

Pipe Diameter, Nominal:

SE16A: Recommended for 15 mm to 50 mm (0.5 in to 2 in); Suitable for 50 mm to 150 mm (2 in to 6 in)
 SE16B: Recommended for 50 mm to 250 mm (2 in to 10 in); Suitable for 250 mm to 1,200 mm (10 in to 48 in)
 SE16C: Recommended for 300 mm to 1,200 mm (12 in to 48 in); Suitable for 100 mm to 300 mm (4 in to 12 in)

Pipe Materials:

Any metal or plastic sonic conducting material including carbon steel, stainless steel, ductile iron, concrete-lined ductile iron, cast iron, PVC, HDPE, PVDF, fiberglass, copper, brass, aluminum, and pipes with bonded liners including epoxy, rubber, and Teflon

Flow Velocity:

±0.03 m/s to 12.2 m/s (±0.1 ft/s to 40 ft/s) typical

Operating Frequency:

SE16A: 2.56 MHz
 SE16B: 1.28 MHz
 SE16C: 640 kHz

Operating Temperature:

-40 °C to +150 °C (-40 °F to +300 °F)

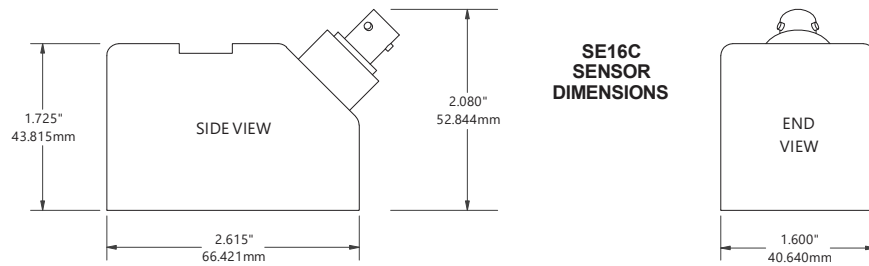
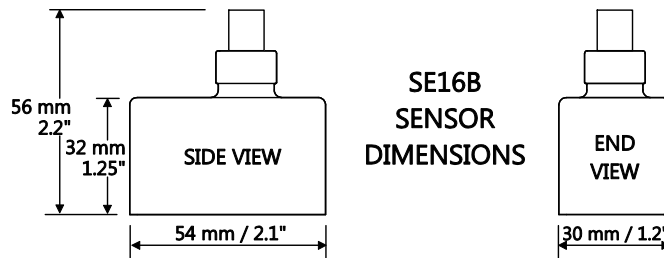
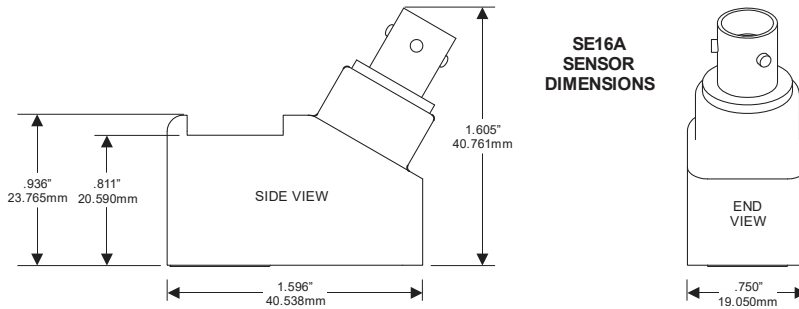

APPENDIX A - CONVERSION TABLE

CONVERSION GUIDE		
FROM	TO	MULTIPLY BY
US GALLONS	CUBIC FEET	0.1337
US GALLONS	IMPERIAL GALS	0.8327
US GALLONS	LITRES	3.785
US GALLONS	CUBIC METERS	0.003785
LITRES/SEC	GPM	15.85
LITRES	CUBIC METERS	0.001
BARRELS	US GALLONS	42
BARRELS	IMPERIAL GALS	34.9726
BARRELS	LITRES	158.9886
INCHES	MM	25.4
DEGREES F	DEGREES C	$(^{\circ}\text{F}-32) \times 0.556$
POUNDS	KILOGRAMS	0.453
PSI	BAR	0.0676
FOOT ²	METER ²	0.0929

Note: BARRELS are U.S. oil barrels.

APPENDIX B - PIPE CHARTS

Carbon Steel & PVC Pipe

Pipe Size	Pipe O.D.	Standard Schedule 40		Extra Heavy Schedule 80		Dbl. Extra Heavy		Schedule 10		Schedule 20		Schedule 30		Schedule 40	
		I.D.	WALL	I.D.	WALL	I.D.	WALL	I.D.	WALL	I.D.	WALL	I.D.	WALL	I.D.	WALL
½	.840	.622	.109	.546	.147	.252	.294							.622	.109
¾	1.050	.824	.113	.742	.154	.434	.308							.824	.113
1	1.315	1.049	.133	.957	.179	.599	.358							1.049	.133
1¼	1.660	1.380	.140	1.278	.191	.896	.382							1.380	.140
1½	1.900	1.610	.145	1.500	.200	1.100	.400							1.610	.145
2	2.375	2.067	.154	1.939	.218	1.503	.436							2.067	.154
2½	2.875	2.469	.203	2.323	.276	1.771	.552							2.469	.203
3	3.500	3.068	.216	2.900	.300	2.300	.600							3.068	.216
3½	4.000	3.548	.226	3.364	.318	2.728	.636							3.548	.226
4	4.500	4.026	.237	3.826	.337	3.152	.674							4.026	.237
5	5.563	5.047	.258	4.813	.375	4.063	.750							5.047	.258
6	6.625	6.065	.280	5.761	.432	4.897	.864							6.065	.280
8	8.625	7.981	.322	7.625	.500	6.875	.875			8.125	.250	8.071	.277	7.981	.322
10	10.750	10.020	.365	9.750	.500	8.750	1.000			10.250	.250	10.136	.307	10.020	.365
12	12.750	12.000	.375	11.750	.500	10.750	1.000			12.250	.250	12.090	.330	11.938	.406
14	14.000	13.250	.375	13.000	.500			13.500	.250	13.376	.312	13.250	.375	13.124	.438
16	16.000	15.250	.375	15.000	.500			15.500	.250	15.376	.312	15.250	.375	15.000	.500
18	18.000	17.250	.375	17.000	.500			17.500	.250	17.376	.312	17.124	.438	16.876	.562
20	20.000	19.250	.375	19.000	.500			19.500	.250	19.250	.375	19.000	.500	18.814	.593
22	22.000	21.250	.375	21.000	.500			21.500	.250	21.250	.375	21.000	.500		
24	24.000	23.250	.375	23.000	.500			23.500	.250	23.250	.375	22.876	.562	22.626	.687
26	26.000	25.250	.375	25.000	.500			25.376	.312	25.000	.500				
28	28.000	27.250	.375	27.000	.500			27.376	.312	27.000	.500	26.750	.625		
30	30.000	29.250	.375	29.000	.500			29.376	.312	29.000	.500	28.750	.625		
32	32.000	31.250	.375	31.000	.500			31.376	.312	31.000	.500	30.750	.625		
34	34.000	33.250	.375	33.000	.500			33.376	.312	33.000	.500	32.750	.625		
36	36.000	35.250	.375	35.000	.500			35.376	.312	35.000	.500	34.750	.625		
42	42.000	41.250	.375	41.000	.500					41.000	.500	40.750	.625		

Ductile Iron Pipe - Standard Classes

Size INCH	OUTSIDE DIA. INCH	Class 50		Class 51		Class 52		Class 53		Class 54		Class 55		Class 56		CEMENT LINING	
		WALL	I.D.	WALL	I.D.	WALL	I.D.	WALL	I.D.	WALL	I.D.	WALL	I.D.	WALL	I.D.	**STD THICKNESS	**DOUBLE THICKNESS
		3	3.96			0.25	3.46	0.28	3.40	0.31	3.34	0.34	3.28	0.37	3.22	0.41	3.14
4	4.80			0.26	4.28	0.29	4.22	0.32	4.16	0.35	4.10	0.38	4.04	0.44	3.93		
6	6.90	0.25	6.40	0.28	6.34	0.31	6.28	0.34	6.22	0.37	6.16	0.40	6.10	0.43	6.04	.125	.250
8	9.05	0.27	8.51	0.30	8.45	0.33	8.39	0.36	8.33	0.39	8.27	0.42	8.21	0.45	8.15		
10	11.10	0.39	10.32	0.32	10.46	0.35	10.40	0.38	10.34	0.41	10.28	0.44	10.22	0.47	10.16		
12	13.20	0.31	12.58	0.34	12.52	0.37	12.46	0.40	12.40	0.43	12.34	0.46	12.28	0.49	12.22		
14	15.30	0.33	14.64	0.36	14.58	0.39	14.52	0.42	14.46	0.45	14.40	0.48	14.34	0.51	14.28		
16	17.40	0.34	16.72	0.37	16.66	0.40	16.60	0.43	16.54	0.46	16.48	0.49	16.42	0.52	16.36	.1875	.375
18	19.50	0.35	18.80	0.38	18.74	0.41	18.68	0.44	18.62	0.47	18.56	0.50	18.50	0.53	18.44		
20	21.60	0.36	20.88	0.39	20.82	0.42	20.76	0.45	20.70	0.48	20.64	0.51	20.58	0.54	20.52		
24	25.80	0.38	25.04	0.41	24.98	0.44	24.92	0.47	24.86	0.50	24.80	0.53	24.74	0.56	24.68		
30	32.00	0.39	31.22	0.43	31.14	0.47	31.06	0.51	30.98	0.55	30.90	0.59	30.82	0.63	30.74	.250	.500
36	38.30	0.43	37.44	0.48	37.34	0.62	37.06	0.58	37.14	0.63	37.04	0.68	36.94	0.73	36.84		
42	44.50	0.47	43.56	0.53	43.44	0.59	43.32	0.65	43.20	0.71	43.08	0.77	42.96	0.83	42.84		
48	50.80	0.51	49.78	0.58	49.64	0.65	49.50	0.72	49.36	0.79	49.22	0.86	49.08	0.93	48.94		
54	57.10	0.57	55.96	0.65	55.80	0.73	55.64	0.81	55.48	0.89	55.32	0.97	55.16	1.05	55.00		

**REDUCE I.D. BY DIMENSION SHOWN

Stainless Steel, Hastelloy "C" & Titanium Pipe

Pipe Size	Pipe O.D.	Schedule 5 S (a)		Schedule 10 S (a)		Schedule 40 S		Schedule 80 S	
		I.D.	WALL	I.D.	WALL	I.D.	WALL	I.D.	WALL
½	.840	.710	.065	.674	.083	.622	.109	.546	.147
¾	1.050	.920	.065	.884	.083	.824	.113	.742	.154
1	1.315	1.185	.065	1.097	.109	1.049	.133	.957	.179
1¼	1.660	1.530	.065	1.442	.109	1.380	.140	1.278	.191
1½	1.900	1.770	.065	1.682	.109	1.610	.145	1.500	.200
2	2.375	2.245	.065	2.157	.109	2.067	.154	1.939	.218
2½	2.875	2.709	.083	2.635	.120	2.469	.203	2.323	.276
3	3.500	3.334	.083	3.260	.120	3.068	.216	2.900	.300
3½	4.000	3.834	.083	3.760	.120	3.548	.226	3.364	.318
4	4.500	4.334	.083	4.260	.120	4.026	.237	3.826	.337
5	5.563	5.345	.109	5.295	.134	5.047	.258	4.813	.375
6	6.625	6.407	.109	6.357	.134	6.065	.280	5.761	.432
8	8.625	8.407	.109	8.329	.148	7.981	.322	7.625	.500
10	10.750	10.482	.134	10.420	.165	10.020	.365	9.750	.500
12	12.750	12.438	.156	12.390	.180	12.000	.375	11.750	.500
14	14.000	13.688	.156	13.624	.188				
16	16.000	15.670	.165	15.624	.188				
18	18.000	17.670	.165	17.624	.188				
20	20.000	19.634	.188	19.564	.218				
22	22.000	21.624	.188	21.564	.218				
24	24.000	23.563	.218	23.500	.250				

Pipe Size	Pipe O.D.	Schedule 60		Schedule 80		Schedule 100		Schedule 120		Schedule 140		Schedule 160	
		I.D.	WALL	I.D.	WALL	I.D.	WALL	I.D.	WALL	I.D.	WALL	I.D.	WALL
½	.840			.546	.147							.466	.187
¾	1.050			.742	.154							.614	.218
1	1.315			.957	.179							.815	.250
1¼	1.660			1.278	.191							1.160	.250
1½	1.900			1.500	.200							1.338	.281
2	2.375			1.939	.218							1.689	.343
2½	2.875			2.323	.276							2.125	.375
3	3.500			2.900	.300							2.624	.438
3½	4.000			3.364	.318								
4	4.500			3.826	.337			3.624	.438			3.438	.531
5	5.563			4.813	.375			4.563	.500			4.313	.625
6	6.625			5.761	.432			5.501	.562			5.189	.718
8	8.625	7.813	.406	7.625	.500	7.439	.593	7.189	.718	7.001	.812	6.813	.906
10	10.750	9.750	.500	9.564	.593	9.314	.718	9.064	.843	8.750	1.000	8.500	1.125
12	12.750	11.626	.562	11.376	.687	11.064	.843	10.750	1.000	10.500	1.125	10.126	1.312
14	14.000	12.814	.593	12.500	.750	12.126	.937	11.814	1.093	11.500	1.250	11.188	1.406
16	16.000	14.688	.656	14.314	.843	13.938	1.031	13.564	1.218	13.124	1.438	12.814	1.593
18	18.000	16.500	.750	16.126	.937	15.688	1.156	15.250	1.375	14.876	1.562	14.438	1.781
20	20.000	18.376	.812	17.938	1.031	17.438	1.281	17.000	1.500	16.500	1.750	16.064	1.968
22	22.000	20.250	.875	19.750	1.125	19.250	1.375	18.750	1.625	18.250	1.875	17.750	2.125
24	24.000	22.064	.968	21.564	1.218	20.938	1.531	20.376	1.812	19.876	2.062	19.314	2.343

Cast Iron Pipe - ASA Standard

Pipe Size	Pipe O.D.	Class 50		Class 100		Class 150		Class 200		Class 250		Class 300		Class 350	
		WALL	I.D.	WALL	I.D.	WALL	I.D.	WALL	I.D.	WALL	I.D.	WALL	I.D.	WALL	I.D.
3	3.96	0.32	3.32	0.32	3.32	0.32	3.32	0.32	3.32	0.32	3.32	0.32	3.32	0.32	3.32
4	4.80	0.35	4.10	0.35	4.10	0.35	4.10	0.35	4.10	0.35	4.10	0.35	4.10	0.35	4.10
6	6.90	0.38	6.14	0.38	6.14	0.38	6.14	0.38	6.14	0.38	6.14	0.38	6.14	0.38	6.14
8	9.05	0.41	8.23	0.41	8.23	0.41	8.23	0.41	8.23	0.41	8.23	0.41	8.23	0.41	8.23
10	11.10	0.44	10.22	0.44	10.22	0.44	10.22	0.44	10.22	0.44	10.22	0.48	10.14	0.52	10.06
12	13.20	0.48	12.24	0.48	12.24	0.48	12.24	0.48	12.24	0.52	12.16	0.52	12.16	0.56	12.08
14	15.30	0.48	14.34	0.51	14.28	0.51	14.28	0.55	14.20	0.59	14.12	0.59	14.12	0.64	14.02
16	17.40	0.54	16.32	0.54	16.32	0.54	16.32	0.58	16.24	0.63	16.14	0.68	16.04	0.68	16.04
18	19.50	0.54	18.42	0.58	18.34	0.58	18.34	0.63	18.24	0.68	18.14	0.73	18.04	0.79	17.92
20	21.60	0.57	20.46	0.62	20.36	0.62	20.36	0.67	20.26	0.72	20.16	0.78	20.04	0.84	19.92
24	25.80	0.63	24.54	0.68	24.44	0.73	24.34	0.79	24.22	0.79	24.22	0.85	24.10	0.92	23.96

Cast Iron Pipe - AWWA Standard

Pipe Size	Class A 100 Ft. 43 PSIG			Class B 200 Ft. 86 PSIG			Class C 300 Ft. 130 PSIG			Class D 400 Ft. 173 PSIG		
	O.D.	WALL	I.D.	O.D.	WALL	I.D.	O.D.	WALL	I.D.	O.D.	WALL	I.D.
3	3.80	0.39	3.02	3.96	0.42	3.12	3.96	0.45	3.06	3.96	0.48	3.00
4	4.80	0.42	3.96	5.00	0.45	4.10	5.00	0.48	4.04	5.00	0.52	3.96
6	6.90	0.44	6.02	7.10	0.48	6.14	7.10	0.51	6.08	7.10	0.55	6.00
8	9.05	0.46	8.13	9.05	0.51	8.03	9.30	0.56	8.18	9.30	0.60	8.10
10	11.10	0.50	10.10	11.10	0.57	9.96	11.40	0.62	10.16	11.40	0.68	10.04
12	13.20	0.54	12.12	13.20	0.62	11.96	13.50	0.68	12.14	13.50	0.75	12.00
14	15.30	0.57	14.16	15.30	0.66	13.98	15.65	0.74	14.17	15.65	0.82	14.01
16	17.40	0.60	16.20	17.40	0.70	16.00	17.80	0.80	16.20	17.80	0.89	16.02
18	19.50	0.64	18.22	19.50	0.75	18.00	19.92	0.87	18.18	19.92	0.96	18.00
20	21.60	0.67	20.26	21.60	0.80	20.00	22.06	0.92	20.22	22.06	1.03	20.00
24	25.80	0.76	24.28	25.80	0.89	24.02	26.32	1.04	24.22	26.32	1.16	24.00
30	31.74	0.88	29.98	32.00	1.03	29.94	32.40	1.20	30.00	32.74	1.37	30.00
36	37.96	0.99	35.98	38.30	1.15	36.00	38.70	1.36	39.98	39.16	1.58	36.00
42	44.20	1.10	42.00	44.50	1.28	41.94	45.10	1.54	42.02	45.58	1.78	42.02
48	50.50	1.26	47.98	50.80	1.42	47.96	51.40	1.71	47.98	51.98	1.96	48.06
54	56.66	1.35	53.96	57.10	1.55	54.00	57.80	1.90	54.00	58.40	2.23	53.94
60	62.80	1.39	60.02	63.40	1.67	60.06	64.20	2.00	60.20	64.82	2.38	60.06
72	75.34	1.62	72.10	76.00	1.95	72.10	76.88	2.39	72.10			
84	87.54	1.72	84.10	88.54	2.22	84.10						

Pipe Size	Class E 500 Ft. 217 PSIG			Class F 600 Ft. 260 PSIG			Class G 700 Ft. 304 PSIG			Class H 800 Ft. 347 PSIG		
	O.D.	WALL	I.D.	O.D.	WALL	I.D.	O.D.	WALL	I.D.	O.D.	WALL	I.D.
6	7.22	0.58	6.06	7.22	0.61	6.00	7.38	0.65	6.08	7.38	0.69	6.00
8	9.42	0.66	8.10	9.42	0.71	8.00	9.60	0.75	8.10	9.60	0.80	8.00
10	11.60	0.74	10.12	11.60	0.80	10.00	11.84	0.86	10.12	11.84	0.92	10.00
12	13.78	0.82	12.14	13.78	0.89	12.00	14.08	0.97	12.14	14.08	1.04	12.00
14	15.98	0.90	14.18	15.98	0.99	14.00	16.32	1.07	14.18	16.32	1.16	14.00
16	18.16	0.98	16.20	18.16	1.08	16.00	18.54	1.18	16.18	18.54	1.27	16.00
18	20.34	1.07	18.20	20.34	1.17	18.00	20.78	1.28	18.22	20.78	1.39	18.00
20	22.54	1.15	20.24	22.54	1.27	20.00	23.02	1.39	20.24	23.02	1.51	20.00
24	26.90	1.31	24.28	26.90	1.45	24.00	27.76	1.75	24.26	27.76	1.88	24.00
30	33.10	1.55	30.00	33.46	1.73	30.00						
36	39.60	1.80	36.00	40.04	2.02	36.00						

Copper Tubing

Pipe Size	K			L			M			Copper & Brass Pipe			Aluminum		
	O.D.	I.D.	WALL	O.D.	I.D.	WALL	O.D.	I.D.	WALL	O.D.	I.D.	WALL	O.D.	I.D.	WALL
½"	0.625	0.527	0.049	0.625	0.545	0.040	0.625	0.569	0.028	0.840	0.625	0.108			
⅝"	0.750	0.652	0.049	0.750	0.666	0.042	0.750	0.690	0.030						
¾"	0.875	0.745	0.065	0.875	0.785	0.045	0.875	0.811	0.032	1.050	0.822	0.114			
1"	1.125	0.995	0.065	1.125	1.025	0.050	1.125	1.055	0.035	1.315	1.062	0.127			
1 ¼"	1.375	1.245	0.065	1.375	1.265	0.055	1.375	1.291	0.042	1.660	1.368	0.146			
1 ½"	1.625	1.481	0.072	1.625	1.505	0.060	1.625	1.527	0.049	1.900	1.600	0.150			
2"	2.125	1.959	0.083	2.125	1.985	0.070	2.125	2.009	0.058	2.375	2.062	0.157			
2 ½"	2.625	2.435	0.095	2.625	2.465	0.080	2.625	2.495	0.065	2.875	2.500	0.188	2.500	2.400	0.050
3"	3.125	2.907	0.109	3.125	2.945	0.090	3.125	2.981	0.072	3.500	3.062	0.219	3.000	2.900	0.050
3 ½"	3.625	3.385	0.120	3.625	3.425	0.100	3.625	3.459	0.083	4.000	3.500	0.250			
4"	4.125	3.857	0.134	4.125	3.905	0.110	4.125	3.935	0.095	4.500	3.935	0.095	4.000	4.000	0.250
4 ½"													5.000	4.500	0.250
5"	5.125	4.805	0.160	5.125	4.875	0.125	5.125	4.907	0.109	5.563	5.063	0.250	5.000	4.874	0.063
6"	6.125	5.741	0.192	6.125	5.845	0.140	6.125	5.881	0.122	6.625	6.125	0.250	6.000	5.874	0.063
7"										7.625	7.062	0.282	7.000	6.844	0.078
8"	8.125	7.583	0.271	8.125	7.725	0.200	8.125	7.785	0.170	8.625	8.000	0.313	8.000	7.812	0.094
10"	10.125	9.449	0.338	10.125	9.625	0.250	10.125	9.701	0.212	10.000	9.812	0.094			
12"	12.125	11.315	0.405	12.125	11.565	0.280	12.125	11.617	0.254						

APPENDIX C – LIQUID SPEED OF SOUND DATA

Substance	Form Index	Specific Gravity	Sound Speed m/sec.	v/°C - m/s/°C Δ
Acetic anhydride (22)	(CH ₃ CO) ₂ O	1.082 (20°C)	1180	2.5
Acetic acid, anhydride (22)	(CH ₃ CO) ₂ O	1.082 (20°C)	1180	2.5
Acetic acid, nitrile	C ₂ H ₃ N	0.783	1290	4.1
Acetic acid, ethyl ester (33)	C ₄ H ₈ O ₂	0.901	1085	4.4
Acetic acid, methyl ester	C ₃ H ₆ O ₂	0.934	1211	
Acetone	C ₃ H ₆ O	0.791	1174	4.5
Acetonitrile	C ₂ H ₃ N	0.783	1290	4.1
Acetylacetone	C ₆ H ₁₀ O ₂	0.729	1399	3.6
Acetylene dichloride	C ₂ H ₂ Cl ₂	1.26	1015	3.8
Acetylene tetrabromide (47)	C ₂ H ₂ Br ₄	2.966	1027	
Acetylene tetrachloride (47)	C ₂ H ₂ Cl ₄	1.595	1147	
Alcohol	C ₂ H ₆ O	0.789	1207	4.0
Alkazene-13	C ₁₅ H ₂₄	0.86	1317	3.9
Alkazene-25	C ₁₀ H ₁₂ Cl ₂	1.20	1307	3.4
2-Amino-ethanol	C ₂ H ₇ NO	1.018	1724	3.4
2-Aminotolidine (46)	C ₇ H ₉ N	0.999 (20°C)	1618	
4-Aminotolidine (46)	C ₇ H ₉ N	0.966 (45°C)	1480	
Ammonia (35)	NH ₃	0.771	1729	6.68
Amorphous Polyolefin		0.98	962.6	
t-Amyl alcohol	C ₅ H ₁₂ O	0.81	1204	
Aminobenzene (41)	C ₆ H ₅ NO ₂	1.022	1639	4.0
Aniline (41)	C ₆ H ₅ NO ₂	1.022	1639	4.0
Argon (45)	Ar	1.400 (-188°C)	853	
Azine	C ₆ H ₅ N	0.982	1415	4.1
Benzene (29,40,41)	C ₆ H ₆	0.879	1306	4.65
Benzol(29,40,41)	C ₆ H ₆	0.879	1306	4.65
Bromine (21)	Br ₂	2.928	889	3.0
Bromo-benzene (46)	C ₆ H ₅ Br	1.522	1170	
1-Bromo-butane (46)	C ₄ H ₉ Br	1.276 (20°C)	1019	
Bromo-ethane (46)	C ₂ H ₅ Br	1.460 (20°C)	900	
Bromoform (46,47)	CHBr ₃	2.89 (20°C)	918	3.1
n-Butane (2)	C ₄ H ₁₀	0.601 (0°C)	1085	5.8
2-Butanol	C ₄ H ₁₀ O	0.81	1240	3.3
sec-Butylalcohol	C ₄ H ₁₀ O	0.81	1240	3.3
n-Butyl bromide (46)	C ₄ H ₉ Br	1.276 (20°C)	1019	
n-Butyl chloride (22,46)	C ₄ H ₉ Cl	0.887	1140	4.57
tert Butyl chloride	C ₄ H ₉ Cl	0.84	984	4.2
Butyl oleate	C ₂₂ H ₄₂ O ₂		1404	3.0
2,3 Butylene glycol	C ₄ H ₁₀ O ₂	1.019	1484	1.51
Cadmium (7)	Cd		2237.7	
Carbinol (40,41)	CH ₄ O	0.791 (20°C)	1076	2.92
Carbitol	C ₆ H ₁₄ O ₃	0.988	1458	
Carbon dioxide (26)	CO ₂	1.101 (-37°C)	839	7.71
Carbon disulphide	CS ₂	1.261 (22°C)	1149	
Carbon tetrachloride(33,35,47)	CCl ₄	1.595 (20°C)	926	2.48

Substance	Form Index	Specific Gravity	Sound Speed m/sec.	v/°C - m/s/°C Δ
Carbon tetrafluoride (14)	CF ₄	1.75 (-150°C)	875.2	6.61
Cetane (23)	C ₁₆ H ₃₄	0.773 (20°C)	1338	3.71
Chloro-benzene	C ₆ H ₅ Cl	1.106	1273	3.6
1-Chloro-butane (22,46)	C ₄ H ₉ Cl	0.887	1140	4.57
Chloro-diFluoromethane (3) (Freon 22)	CHClF ₂	1.491 (-69°C)	893.9	4.79
Chloroform (47)	CHCl ₃	1.489	979	3.4
1-Chloro-propane (47)	C ₃ H ₇ Cl	0.892	1058	
Chlorotrifluoromethane (5)	CClF ₃		724	5.26
Cinnamaldehyde	C ₉ H ₈ O	1.112	1554	3.2
Cinnamic aldehyde	C ₉ H ₈ O	1.112	1554	3.2
Colamine	C ₂ H ₇ NO	1.018	1724	3.4
o-Cresol (46)	C ₇ H ₈ O	1.047 (20°C)	1541	
m-Cresol (46)	C ₇ H ₈ O	1.034 (20°C)	1500	
Cyanomethane	C ₂ H ₃ N	0.783	1290	4.1
Cyclohexane (15)	C ₆ H ₁₂	0.779 (20°C)	1248	5.41
Cyclohexanol	C ₆ H ₁₂ O	0.962	1454	3.6
Cyclohexanone	C ₆ H ₁₀ O	0.948	1423	4.0
Decane (46)	C ₁₀ H ₂₂	0.730	1252	
1-Decene (27)	C ₁₀ H ₂₀	0.746	1235	4.0
n-Decylene (27)	C ₁₀ H ₂₀	0.746	1235	4.0
Diacetyl	C ₄ H ₆ O ₂	0.99	1236	4.6
Diamylamine	C ₁₀ H ₂₃ N		1256	3.9
1,2 Dibromo-ethane (47)	C ₂ H ₄ Br ₂	2.18	995	
trans-1,2-Dibromoethene(47)	C ₂ H ₂ Br ₂	2.231	935	
Dibutyl phthalate	C ₈ H ₂₂ O ₄		1408	
Dichloro-t-butyl alcohol	C ₄ H ₈ Cl ₂ O		1304	3.8
2,3 Dichlorodioxane	C ₂ H ₆ Cl ₂ O ₂		1391	3.7
Dichlorodifluoromethane (3) (Freon 12)	CCl ₂ F ₂	1.516 (-40°C)	774.1	4.24
1,2 Dichloro ethane (47)	C ₂ H ₄ Cl ₂	1.253	1193	
cis 1,2-Dichloro-Ethene(3,47)	C ₂ H ₂ Cl ₂	1.284	1061	
trans 1,2-Dichloro-ethene(3,47)	C ₂ H ₂ Cl ₂	1.257	1010	
Dichloro-fluoromethane (3) (Freon 21)	CHCl ₂ F	1.426 (0°C)	891	3.97
1-2-Dichlorohexafluoro cyclobutane (47)	C ₄ Cl ₂ F ₆	1.654	669	
1-3-Dichloro-isobutane	C ₄ H ₈ Cl ₂	1.14	1220	3.4
Dichloro methane (3)	CH ₂ Cl ₂	1.327	1070	3.94
1,1-Dichloro-1,2,2,2 tetra fluoroethane	CClF ₂ -CClF ₂	1.455	665.3	3.73
Diethyl ether	C ₄ H ₁₀ O	0.713	985	4.87
Diethylene glycol, monoethyl ether	C ₆ H ₁₄ O ₃	0.988	1458	
Diethylenimide oxide	C ₄ H ₉ NO	1.00	1442	3.8
1,2-bis(DiFluoramino) butane (43)	C ₄ H ₈ (NF ₂) ₂	1.216	1000	
1,2bis(DiFluoramino)- 2-methylpropane (43)	C ₄ H ₉ (NF ₂) ₂	1.213	900	
1,2bis(DiFluoramino) propane (43)	C ₃ H ₆ (NF ₂) ₂	1.265	960	
2,2bis(DiFluoramino) propane (43)	C ₃ H ₆ (NF ₂) ₂	1.254	890	
2,2-Dihydroxydiethyl ether	C ₄ H ₁₀ O ₃	1.116	1586	2.4
Dihydroxyethane	C ₂ H ₆ O ₂	1.113	1658	2.1

Substance	Form Index	Specific Gravity	Sound Speed m/sec.	v/°C - m/s/°C Δ
1,3-Dimethyl-benzene (46)	C ₈ H ₁₀	0.868 (15°C)	1343	
1,2-1.0Dimethyl-benzene(29,46)	C ₈ H ₁₀	0.897 (20°C)	1331.5	4.1
1,4-Dimethyl-benzene (46)	C ₈ H ₁₀		1334	
2,2-Dimethyl-butane (29,33)	C ₆ H ₁₄	0.649 (20°C)	1079	
Dimethyl ketone	C ₃ H ₆ O	0.791	1174	4.5
Dimethyl pentane (47)	C ₇ H ₁₆	0.674	1063	
Dimethyl phthalate	C ₈ H ₁₀ O ₄	1.2	1463	
Diiodo-methane	CH ₂ I ₂	3.235	980	
Dioxane	C ₄ H ₈ O ₂	1.033	1376	
Dodecane (23)	C ₁₂ H ₂₆	0.749	1279	3.85
1,2-Ethanediol	C ₂ H ₆ O ₂	1.113	1658	2.1
Ethanenitrile	C ₂ H ₃ N	0.783	1290	
Ethanoic anhydride (22)	(CH ₃ CO) ₂ O	1.082	1180	
Ethanol	C ₂ H ₆ O	0.789	1207	4.0
Ethanol amide	C ₂ H ₇ NO	1.018	1724	3.4
Ethoxyethane	C ₄ H ₁₀ O	0.713	985	4.87
Ethyl acetate (33)	C ₄ H ₈ O ₂	0.901	1085	4.4
Ethyl alcohol	C ₂ H ₆ O	0.789	1207	4.0
Ethyl benzene (46)	C ₈ H ₁₀	0.867(20°C)	1338	
Ethyl bromide (46)	C ₂ H ₅ Br	1.461 (20°C)	900	
Ethyl iodide (46)	C ₂ H ₅ I	1.950 (20°C)	876	
Ether	C ₄ H ₁₀ O	0.713	985	4.87
Ethyl ether	C ₄ H ₁₀ O	0.713	985	4.87
Ethylene bromide (47)	C ₂ H ₄ Br ₂	2.18	995	
Ethylene chloride (47)	C ₂ H ₄ Cl ₂	1.253	1193	
Ethylene glycol	C ₂ H ₆ O ₂	1.113	1658	2.1
50% Glycol/ 50% H ₂ O			1578	
d-Fenochone	C ₁₀ H ₁₆ O	0.947	1320	
d-2-Fenechanone	C ₁₀ H ₁₆ O	0.947	1320	
Fluorine	F	0.545 (-143°C)	403	11.31
Fluoro-benzene (46)	C ₆ H ₅ F	1.024 (20°C)	1189	
Formaldehyde, methyl ester	C ₂ H ₄ O ₂	0.974	1127	4.02
Formamide	CH ₃ NO	1.134 (20°C)	1622	2.2
Formic acid, amide	CH ₃ NO	1.134 (20°C)	1622	
Freon R12			774	
Furfural	C ₅ H ₄ O ₂	1.157	1444	
Furfuryl alcohol	C ₅ H ₆ O ₂	1.135	1450	3.4
Fural	C ₅ H ₄ O ₂	1.157	1444	3.7
2-Furaldehyde	C ₅ H ₄ O ₂	1.157	1444	3.7
2-Furancarboxaldehyde	C ₅ H ₄ O ₂	1.157	1444	3.7
2-Furyl-Methanol	C ₅ H ₆ O ₂	1.135	1450	3.4
Gallium	Ga	6.095	2870 (@30°C)	
Glycerin	C ₃ H ₈ O ₃	1.26	1904	2.2
Glycerol	C ₃ H ₈ O ₃	1.26	1904	2.2
Glycol	C ₂ H ₆ O ₂	1.113	1658	2.1

Substance	Form Index	Specific Gravity	Sound Speed m/sec.	v/°C - m/s/°C Δ
Helium (45)	He4	0.125(-268.8°C)	183	
Heptane (22,23)	C7H16	0.684 (20°C)	1131	4.25
n-Heptane (29,33)	C7H16	0.684 (20°C)	1180	4.0
Hexachloro-Cyclopentadiene(47)	C5Cl6	1.7180	1150	
Hexadecane (23)	C16H34	0.773 (20°C)	1338	3.71
Hexalin	C6H12O	0.962	1454	3.6
Hexane (16,22,23)	C6H14	0.659	1112	2.71
n-Hexane (29,33)	C6H14	0.649 (20°C)	1079	4.53
2,5-Hexanedione	C6H10O2	0.729	1399	3.6
n-Hexanol	C6H14O	0.819	1300	3.8
Hexahydrobenzene (15)	C6H12	0.779	1248	5.41
Hexahydrophenol	C6H12O	0.962	1454	3.6
Hexamethylene (15)	C6H12	0.779	1248	5.41
Hydrogen (45)	H2	0.071 (-256°C)	1187	
2-Hydroxy-toluene (46)	C7H8O	1.047 (20°C)	1541	
3-Hydroxy-toluene (46)	C7H8O	1.034 (20°C)	1500	
Iodo-benzene (46)	C6H5I	1.823	1114	
Iodo-ethane (46)	C2H5I	1.950 (20°C)	876	
Iodo-methane	CH3I	2.28 (20°C)	978	
Isobutyl acetate (22)	C6H12O		1180	4.85
Isobutanol	C4H10O	0.81 (20°C)	1212	
Iso-Butane			1219.8	
Isopentane (36)	C5H12	0.62 (20°C)	980	4.8
Isopropanol (46)	C3H8O	0.785 (20°C)	1170	
Isopropyl alcohol (46)	C3H8O	0.785 (20°C)	1170	
Kerosene		0.81	1324	3.6
Ketohexamethylene	C6H10O	0.948	1423	4.0
Lithium fluoride (42)	LiF		2485	1.29
Mercury (45)	Hg	13.594	1449	
Mesityloxiide	C6H16O	0.85	1310	
Methane (25,28,38,39)	CH4	0.162	405(-89.15°C)	17.5
Methanol (40,41)	CH4O	0.791 (20°C)	1076	2.92
Methyl acetate	C3H6O2	0.934	1211	
o-Methylaniline (46)	C7H9N	0.999 (20°C)	1618	
4-Methylaniline (46)	C7H9N	0.966 (45°C)	1480	
Methyl alcohol (40,44)	CH4O	0.791 (20°C)	1076	2.92
Methyl benzene (16,52)	C7H8	0.867	1328	4.27
2-Methyl-butane (36)	C5H12	0.62 (20°C)	980	
Methyl carbinol	C2H6O	0.789	1207	4.0
Methyl-chloroform (47)	C2H3Cl3	1.33	985	
Methyl-cyanide	C2H3N	0.783	1290	
3-Methyl cyclohexanol	C7H14O	0.92	1400	
Methylene chloride (3)	CH2Cl2	1.327	1070	3.94
Methylene iodide	CH2I2	3.235	980	
Methyl formate (22)	C2H4O2	0.974 (20°C)	1127	4.02

Substance	Form Index	Specific Gravity	Sound Speed m/sec.	v/°C - m/s/°C Δ
Methyl iodide	CH ₃ I	2.28 (20°C)	978	
2-Methylphenol (46)	C ₇ H ₈ O	1.047 (20°C)	1541	
3-Methylphenol (46)	C ₇ H ₈ O	1.034 (20°C)	1500	
Milk, homogenized			1548	
Morpholine	C ₄ H ₉ NO	1.00	1442	3.8
Naphtha		0.76	1225	
Natural Gas (37)		0.316 (-103°C)	753	
Neon (45)	Ne	1.207 (-246°C)	595	
Nitrobenzene (46)	C ₆ H ₅ NO ₂	1.204 (20°C)	1415	
Nitrogen (45)	N ₂	0.808 (-199°C)	962	
Nitromethane (43)	CH ₃ NO ₂	1.135	1300	4.0
Nonane (23)	C ₉ H ₂ O	0.718 (20°C)	1207	4.04
1-Nonene (27)	C ₉ H ₁₈	0.736 (20°C)	1207	4.0
Octane (23)	C ₈ H ₁₈	0.703	1172	4.14
n-Octane (29)	C ₈ H ₁₈	0.704 (20°C)	1212.5	3.50
1-Octene (27)	C ₈ H ₁₆	0.723 (20°C)	1175.5	4.10
Oil of Camphor Sassafrassy			1390	3.8
Oil, Car (SAE 20a.30)	1.74		870	
Oil, Castor	C ₁₁ H ₁₀ O ₁₀	0.969	1477	3.6
Oil, Diesel		0.80	1250	
Oil, Fuel AA gravity		0.99	1485	3.7
Oil (Lubricating X200)			1530	5019.9
Oil (Olive)		0.912	1431	2.75
Oil (Peanut)		0.936	1458	
Oil (Sperm)		0.88	1440	
Oil, 6			1509	
2,2-Oxydiethanol	C ₄ H ₁₀ O ₃	1.116	1586	2.4
Oxygen (45)	O ₂	1.155 (-186°C)	952	
Pentachloro-ethane (47)	C ₂ HCl ₅	1.687	1082	
Pentalin (47)	C ₂ HCl ₅	1.687	1082	
Pentane (36)	C ₅ H ₁₂	0.626 (20°C)	1020	
n-Pentane (47)	C ₅ H ₁₂	0.557	1006	
Perchlorocyclopentadiene(47)	C ₅ Cl ₆	1.718	1150	
Perchloro-ethylene (47)	C ₂ Cl ₄	1.632	1036	
Perfluoro-1-Hepten (47)	C ₇ F ₁₄	1.67	583	
Perfluoro-n-Hexane (47)	C ₆ F ₁₄	1.672	508	
Phene (29,40,41)	C ₆ H ₆	0.879	1306	4.65
β-Phenyl acrolein	C ₉ H ₈ O	1.112	1554	3.2
Phenylamine (41)	C ₆ H ₅ NO ₂	1.022	1639	4.0
Phenyl bromide (46)	C ₆ H ₅ Br	1.522	1170	
Phenyl chloride	C ₆ H ₅ Cl	1.106	1273	3.6
Phenyl iodide (46)	C ₆ H ₅ I	1.823	1114	
Phenyl methane (16,52)	C ₇ H ₈	0.867 (20°C)	1328	4.27

Substance	Form Index	Specific Gravity	Sound Speed m/sec.	v/°C - m/s/°C Δ
3-Phenyl propenal	C ₉ H ₈ O	1.112	1554	3.2
Phthalardione	C ₈ H ₄ O ₃		1125	
Phthalic acid, anhydride	C ₈ H ₄ O ₃		1125	
Phthalic anhydride	C ₈ H ₄ O ₃		1125	
Pimelic ketone	C ₆ H ₁₀ O	0.948	1423	4.0
Plexiglas, Lucite, Acrylic			2651	
Polyterpene Resin		0.77	1099.8	
Potassium bromide (42)	Kbr		1169	0.71
Potassium fluoride (42)	KF		1792	1.03
Potassium iodide (42)	KI		985	0.64
Potassium nitrate (48)	KNO ₃	1.859 (352°C)	1740.1	1.1
Propane (2,13)(-45 to -130°C)	C ₃ H ₈	0.585 (-45°C)	1003	5.7
1,2,3-Propanetriol	C ₃ H ₈ O ₃	1.26	1904	2.2
1-Propanol (46)	C ₃ H ₈ O	0.78 (20°C)	1222	
2-Propanol (46)	C ₃ H ₈ O	0.785 (20°C)	1170	
2-Propanone	C ₃ H ₆ O	0.791	1174	4.5
Propene (17,18,35)	C ₃ H ₆	0.563 (-13°C)	963	6.32
n-Propyl acetate (22)	C ₅ H ₁₀ O ₂	1280 (2°C)	4.63	
n-Propyl alcohol	C ₃ H ₈ O	0.78 (20°C)	1222	
Propylchloride (47)	C ₃ H ₇ Cl	0.892	1058	
Propylene (17,18,35)	C ₃ H ₆	0.563 (-13°C)	963	6.32
Pyridine	C ₆ H ₅ N	0.982	1415	4.1
Refrigerant 11 (3,4)	CCl ₃ F	1.49	828.3	3.56
Refrigerant 12 (3)	CCl ₂ F ₂	1.516 (-40°C)	774.1	4.24
Refrigerant 14 (14)	CF ₄	1.75 (-150°C)	875.24	6.61
Refrigerant 21 (3)	CHCl ₂ F	1.426 (0°C)	891	3.97
Refrigerant 22 (3)	CHClF ₂	1.491 (-69°C)	893.9	4.79
Refrigerant 113 (3)	CCl ₂ F-CClF ₂	1.563	783.7	3.44
Refrigerant 114 (3)	CClF ₂ -CClF ₂	1.455	665.3	3.73
Refrigerant 115 (3)	C ₂ ClF ₅		656.4	4.42
Refrigerant C318 (3)	C ₄ F ₈	1.62 (-20°C)	574	3.88
Selenium (8)	Se		1072	0.68
Silicone (30 cp)		0.993	990	
Sodium fluoride (42)	NaF	0.877	2082	1.32
Sodium nitrate (48)	NaNO ₃	1.884 (336°C)	1763.3	0.74
Sodium nitrite (48)	NaNO ₂	1.805 (292°C)	1876.8	
Solvesso 3		0.877	1370	3.7
Spirit of wine	C ₂ H ₆ O	0.789	1207	4.0
Sulphur (7,8,10)	S		1177	-1.13
Sulphuric acid (1)	H ₂ SO ₄	1.841	1257.6	1.43
Tellurium (7)	Te		991	0.73
1,1,2,2-Tetrabromo-ethane(47)	C ₂ H ₂ Br ₄	2.966120	1027	
1,1,2,2-Tetrachloro-ethane(67)	C ₂ H ₂ Cl ₄	1.595	1147	
Tetrachloroethane (46)	C ₂ H ₂ Cl ₄	1.553 (20°C)	1170	
Tetrachloro-ethene (47)	C ₂ Cl ₄	1.632	1036	

Substance	Form Index	Specific Gravity	Sound Speed m/sec.	v/°C - m/s/°C Δ
Tetrachloro-methane (33,47)	CCl ₄	1.595 (20°C)	926	
Tetradecane (46)	C ₁₄ H ₃₀	0.763 (20°C)	1331	
Tetraethylene glycol	C ₈ H ₁₈ O ₅	1.123	1586/5203.4	3.0
Tetrafluoro-methane (14) (Freon 14)	CF ₄	1.75 (-150°C)	875.24	6.61
Tetrahydro-1,4-isoxazine	C ₄ H ₉ NO		1442	3.8
Toluene (16,52)	C ₇ H ₈	0.867 (20°C)	1328	4.27
o-Toluidine (46)	C ₇ H ₉ N	0.999 (20°C)	1618	
p-Toluidine (46)	C ₇ H ₉ N	0.966 (45°C)	1480	
Toluol	C ₇ H ₈	0.866	1308	4.2
Tribromo-methane (46,47)	CHBr ₃	2.89 (20°C)	918	
1,1,1-Trichloro-ethane (47)	C ₂ H ₃ Cl ₃	1.33	985	
Trichloro-ethene (47)	C ₂ HCl ₃	1.464	1028	
Trichloro-fluoromethane (3) (Freon 11)	CCl ₃ F	1.49	828.3	3.56
Trichloro-methane (47)	CHCl ₃	1.489	979	3.4
1,1,2-Trichloro-1,2,2-Trifluoro-Ethane	CCl ₂ F-CClF ₂	1.563	783.7	
Triethyl-amine (33)	C ₆ H ₁₅ N	0.726	1123	4.47
Triethylene glycol	C ₆ H ₁₄ O ₄	1.123	1608	3.8
1,1,1-Trifluoro-2-Chloro-2-Bromo-Ethane	C ₂ HClBrF ₃	1.869	693	
1,2,2-Trifluorotrichloro- ethane (Freon 113)	CCl ₂ F-CClF ₂	1.563	783.7	3.44
d-1,3,3-Trimethylnor- camphor	C ₁₀ H ₁₆ O	0.947	1320	
Trinitrotoluene (43)	C ₇ H ₅ (NO ₂) ₃	1.64	1610	
Turpentine		0.88	1255	
Unisis 800		0.87	1346	
Water, distilled (49,50)	H ₂ O	0.996	1498	-2.4
Water, heavy	D ² O		1400	
Water, sea		1.025	1531	-2.4
Wood Alcohol (40,41)	CH ₄ O	0.791 (20°C)	1076	2.92
Xenon (45)	Xe		630	
m-Xylene (46)	C ₈ H ₁₀	0.868 (15°C)	1343	
o-Xylene (29,46)	C ₈ H ₁₀	0.897 (20°C)	1331.5	4.1
p-Xylene (46)	C ₈ H ₁₀		1334	
Xylene hexafluoride	C ₈ H ₄ F ₆	1.37	879	
Zinc (7)	Zn		3298	



www.pulsarmeasurement.com
service@pulsarmeasurement.com

*Copyright © 2020 Pulsar Measurement Ltd.
Registered Address: 1 Chamberlain Square CS, Birmingham B3 3AX
Registered No.: 3345604 England & Wales
Rev 0.1*